

iNELS Air

Sensors & actuators for IoT



ELKO EP



We are traditional, innovative and purely Czech development manufacturer of electronic devices and we have been your partner in the field of electroinstallations for 26 years.

ELKO EP employs about 330 people, exports its products to more than seventy countries, and has representatives in thirteen foreign branches. Company of the Year of the Zlín Region, Visionary of the Year, Global Exporter of the Year, Participation in the Czech TOP 100, these are just some of the awards received. Still, we are not finished. We are constantly striving to move forward in the field of innovation and development. That's our primary concern.

Millions of relays, thousands of satisfied customers, hundreds of our own employees, twenty six years of research, development and production, thirteen foreign branches, one company. ELKO EP, innovative- a purely Czech company based in Holešov, where development, production, logistics, service and support go hand in hand. We primarily focus on developing and manufacturing systems for building automation in the residential, commercial and industrial sector, a wide range of Smart city facilities and the so-called Internet of Things (IoT).



Facts and stats

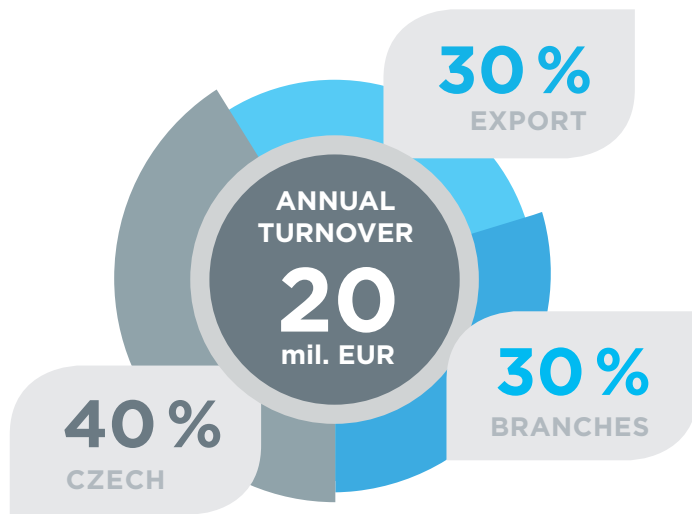

13
BRANCHES OVER
THE WORLDS

70
EXPORTING
COUNTRIES

330
EMPLOYEES

10 000
INELS INSTALLATION

12 000 000
MANUFACTURED PRODUCTS

2nd position
in Europe

WE ARE

DEVELOPERS

In the new R&D center, more than 30 engineers develop new products and extend the functionality of existing products

PRODUCERS

modern antistatic spaces, 2x fully automated SMD production lines, 2 shift operations.

SUPPORT

24 hours / 7 days / 360 days we not only provide technical support but also logistics.

SELLERS

personal access to more than 70 sales representatives in ELKO EP Holding provides impeccable services and superior products at an affordable price.

About iNELS Air

iNELS Air was designed in response to the dynamically developing network for IoT (Internet of Things). The IoT wireless communications category describes the Low Power Wide Area (LPWA). This technology is designed to provide full coverage even inside buildings, with energy-saving and low-cost operation of individual devices.

The product group includes sensors and actuators for communication on the Sigfox, LoRa and NB-IoT protocol. Linking sensors with ELKO Cloud and IFTTT (If This Then That) is ideal for a wide range of applications.

Individual products have the letter “S”, “L” or “NB” in their type designation. This distinguishes the way of communication. “S” stands for communication over the Sigfox network, “L” stands for communication over the LoRa network, and “NB” uses communication via the NarrowBand network.

Smoke detector and Air quality sensors



Weather station



Monitoring of energy



The network supports communication with a limited number of feedbacks. It uses the free frequency band of 868 MHz. It has more extensive coverage across the Czech Republic and abroad and is therefore more suitable for long distance monitoring of the equipment. You can find current network coverage on the site www.sigfox.com.



A bidirectional network using the free band of 868 MHz for its communications. The advantage of this network is the possibility of freely deploying the individual stations in local locations, thus strengthening their signal. It can therefore be used effectively in areas of companies or cities, for example. You can find current network coverage on the site www.lora-alliance.org.



The network is the only one that uses the LTE licensed band for its two-way communication. The advantage of NB-IoT is the use of the already built-in network to ensure adequate coverage both inside and outside buildings. It uses this technology with its SIM card devices. You can find current network coverage on the site <https://www.iot-portal.cz/mapa-pokryti/>.

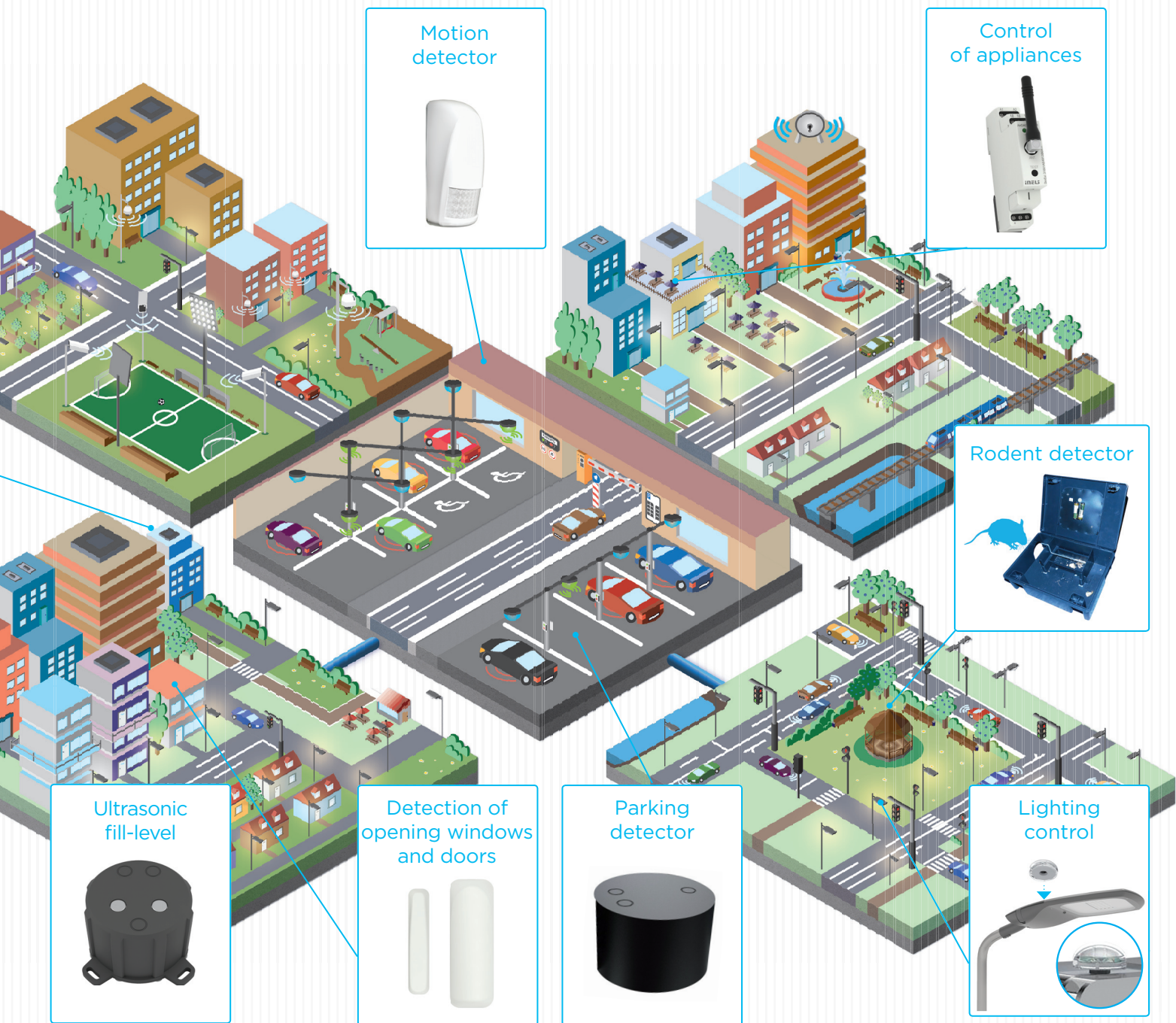

\$ Saving

The use of web-based networks ensures low energy consumption. Thanks to this, most of the sensors can be battery-powered and their capacity can last for an average of 2-5 years. The sensors are simple and affordable. The price for ongoing communication varies depending on the type of network you choose - but in general this communication is considered affordable.

🔒 Safety

All data from the sensors is encrypted before sending, which ensures their security. Access to the individual measured data can then be done in the application or ELKO Cloud under your login information. This can ensure safe and continuous supervision of your property.

💎 Design

The design of the individual products is tailored to their purpose - the design of the detectors is designed for placing into interior spaces, the modular devices into the switchgear and, on the other hand, the products for outdoor use are IP65 compliant. The wireless design of individual devices also enables easy installation and almost immediate use.

Principle function

Data from sensors and actors (further as an „devices“) is sent via transmitters (BTS station) to the control server, from where they are sent to Server. Depending on the user’s requirements, data may be sent to the smartphone application or integrated into the master system.

Installation of individual sensors and detectors is very simple. You will place unit randomly in range of the network. The activation of the sensor is achieved using a QR code, which is placed on each component. For the operation of individual products, it is necessary to have a secure connection with the network provider. This connectivity allows you to select individual intervals for sending messages according to your requirements.

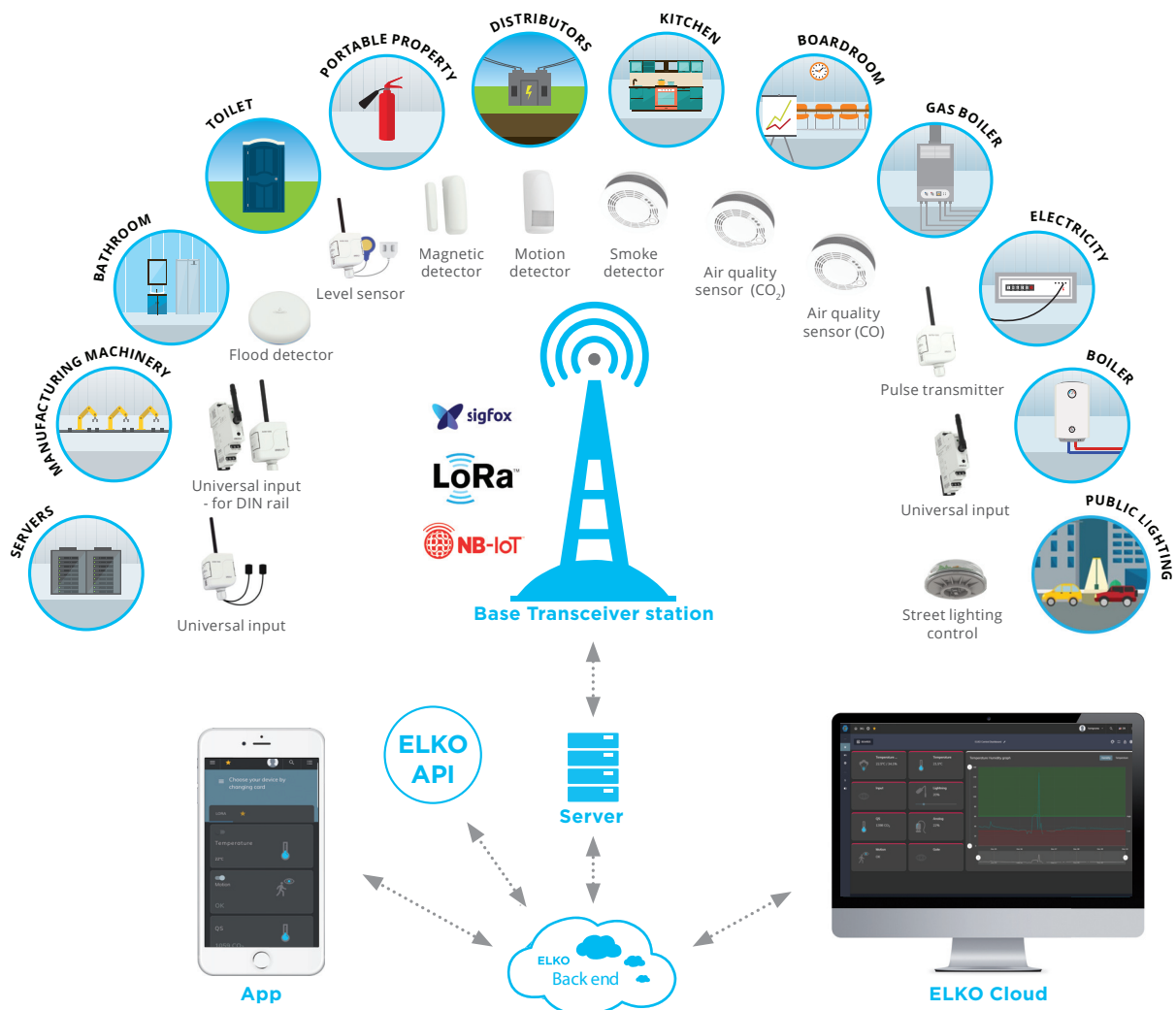

ELKO Cloud

To use the devices from the iNELS Air series, registration is required to the ELKO Cloud or app registration that will collect the current data from these products, store the history and back up your settings. An unlimited number of devices can be assigned to one account.

The possibility of using ELKO Cloud: Cloud for customers of our company. ELKO Cloud is a bridge for smartphone control. User registration can be done at www.elkoep.cloud or easily from iNELS Air. An email contact is always required to set up your account, this will serve as your login name and your account will be authenticated, and your password can be selected.



ELKO Cloud is secured with the SSL protocol.

Uniform product type marking (Type decoding)



AirIM-100S

Product line

Type of devices

- IM** - Universal input
- MD** - Motion detector
- PD** - Parking detector
- QS** - Air Quality sensor
- SA** - Switching actuator
- SD** - Smoke detector
- SF** - Flood detector
- SOU** - Twilight sensor
- TM** - Pulse transmitter
- WD** - Magnetic detector
- SLC** - Street light controller
- WS** - Ultrasonic fill-level

Network

- S** - Sigfox 
- L** - Lora 
- NB** - NB-IoT 

Notification and control

Data from iNELS Air device can be displayed in several variants and combined with each other.

An important carrier of all information and the overall history of each device is the ELKO Backend. From this storage, all statement can then be displayed in your smartphone application, where you can set notifications in the form of a popup window in the top bar of the phone, by message to your email. Using this application offers one of the fastest ways to find out about the current status of your sensors and actors. Linking the device(s) to the ELKO Cloud and IFTTT Interface offers extra countless amounts of information on unwanted situations or alarms.



ELKO Cloud

To easily view data on computer/laptop, is used the ELKO Cloud, which in addition to current statuses also stores the history of sensor data.

www.elkoep.cloud



Application

Simply check the current status of connected power sensors or detectors directly in smartphone. The application offers a user-friendly and intuitive environment.



Notification

The application alerts you to any unwanted status with a popup notification in the top bar of smartphone. Actual informations / changes are available immediately with no need of application check.

There are several ways to control iNELS Air products and view their data:



ELKO Cloud



Application & notification



E-mail

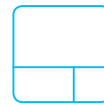

IFTTT



Smart City Platform

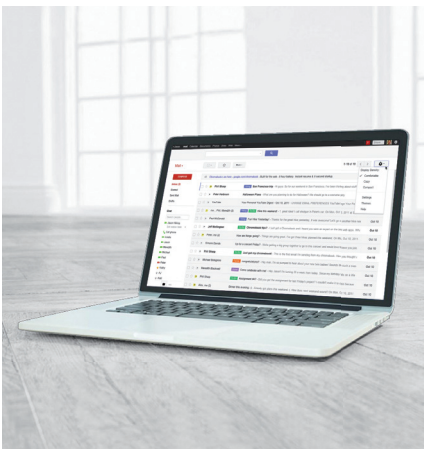

E-mail

You can also be informed about important changes to the monitored devices by receiving a notification email message direct to your e-mail address. For each sensor, e-mail messages can be set separately.



IFTTT

IFTTT is a Cloud Bridge that allows iNELS Air communicates through social networks (Facebook, Instagram, Pinterest, and more). It can also control other compatible products within the app.

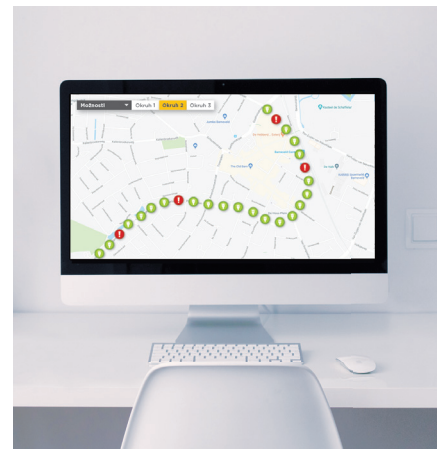

Smart City Platform

The platform is designed specifically for displaying the status of individual sensors and actuators and at the same time control the switching devices in the Smart City. Using a laptop or computer, you can view the city plan and individual installed items to show their current status - for example, free parking spaces.

Measuring and monitoring temperature and humidity

Monitoring the required temperature and not exceeding the set limits is a major problem for many industrial, manufacturing and warehousing process.

The input module can monitor undesirable heating or cooling fluctuations, which are immediately reported. It informs at regular intervals about the actual temperature in the monitored areas. The simple solution is to ensure continuous supervision, thereby eliminating any financial loss caused by overheating or subcooling of the premises or devices.

With its IP65 cover along with battery power makes it ideal for placement in less accessible places.



Universal input

AirIM-100

- In combination with a temperature / humidity sensor it measures and transmits the current data from these sensors (see Page 52)
- timely warnings against critical temperatures
- can be used for other measurements (voltage, current, level, energy, etc.)
- in IP65 enclosure
- technical parametres see Page 26



Examples of use:

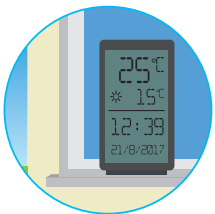

Outdoor temperature measurement

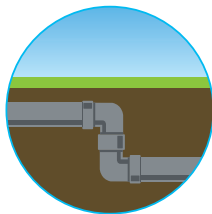

Pipeline (against freezing)

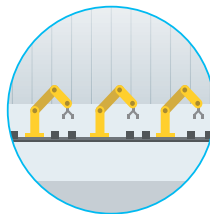

Machines (against overheating)



Server room (correct temperature)

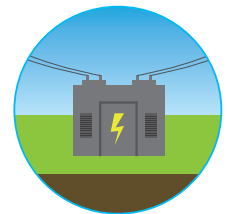

Distribution station

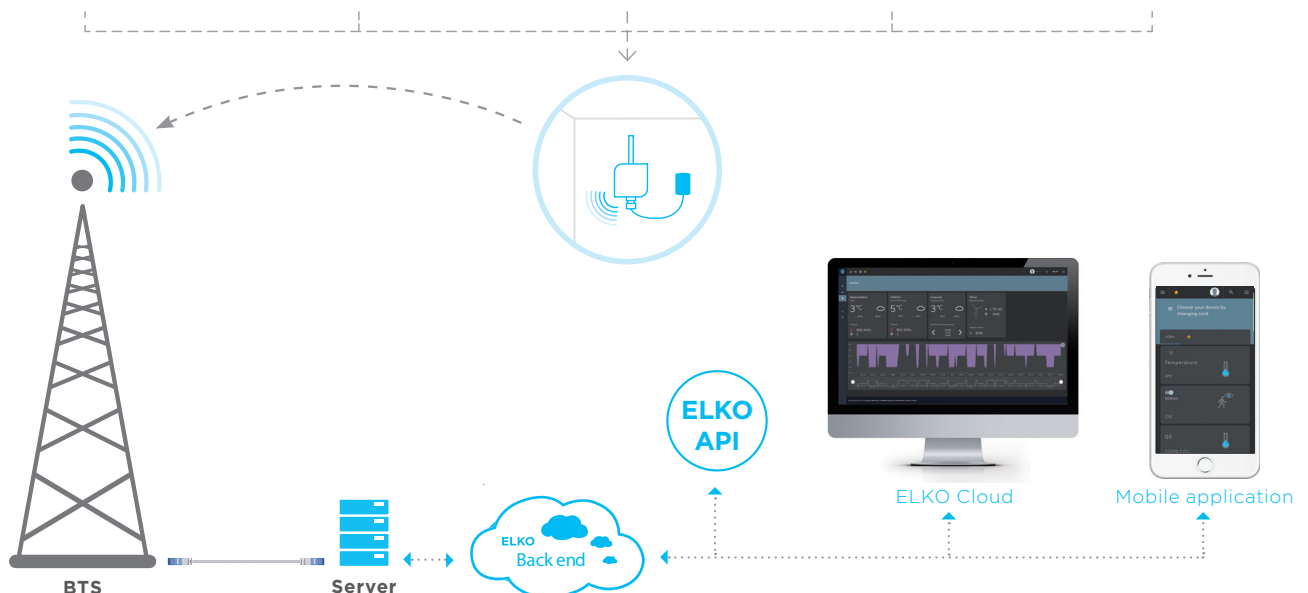

State and device monitoring

The functionality of the equipment and machines is a priority for each manufacturer or operator. Detecting emergencies, critical states and monitoring the current state of the voltage or current of the connected devices can be ensured in a simple way. The universal sensor ensures smooth and seamless operation in the residential and industrial sectors.

When the status or quantity is changed, a message is sent via the BTS transmitter to the ELKO Back-end, from which the data is further redirected to the ELKO Cloud, which can be displayed, for example, in the smartphone's browser. The devices can monitor a value of 0/1, measured at the input voltage of 0 (1)–10 V or current 0 (4)–20 mA or connect the output of the monitoring relays (see www.elkoep.com/products).

Examples of use:

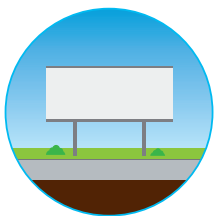

Billboard

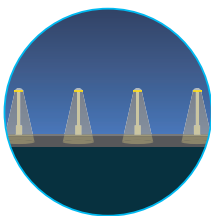

Lighting

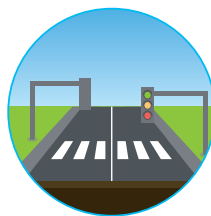

The correct functioning of traffic lights

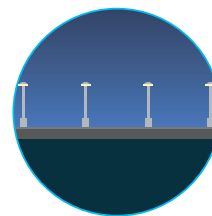

Blackout

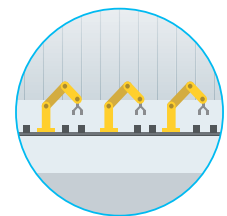

Production machines

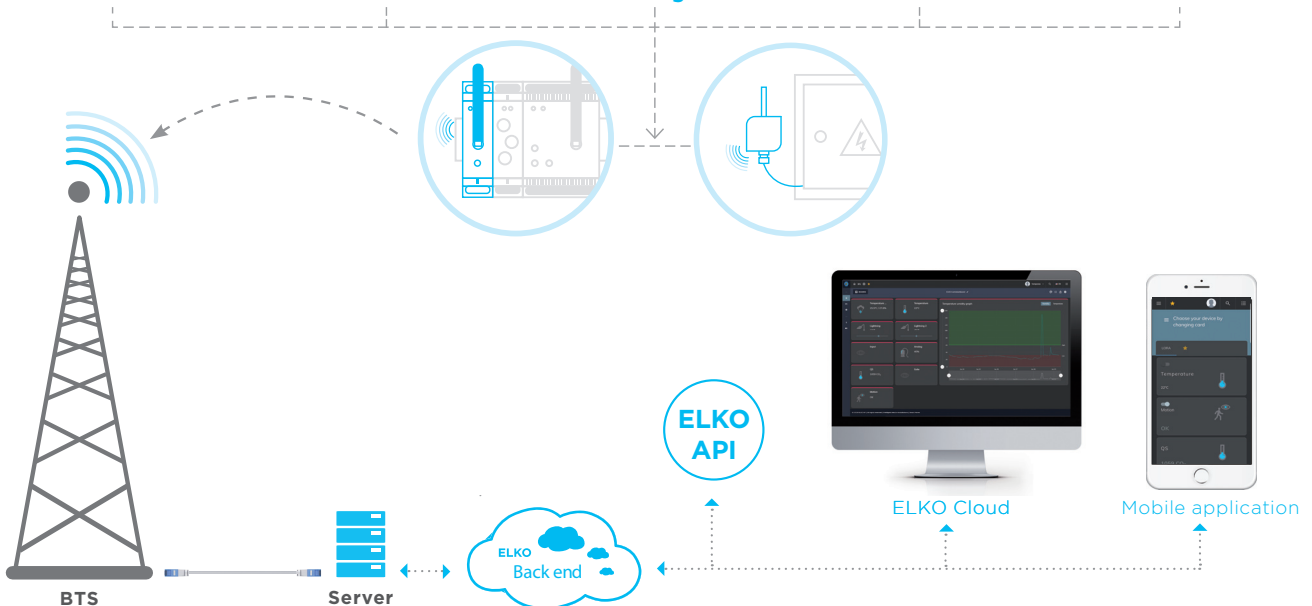

Universal input

AirIM-100



- monitor current state of voltage or current flow
- timely warns when the set voltage/current is exceeded/falls below
- can also be used for other measurements (temperature, humidity, altitude, energy measurements, etc.)
- in IP65 enclosure (Protection against water, dust, ...)
- technical parameters see Page 26



Universal input - for DIN rail

AirIM-100/M



- in conjunction with the relevant monitoring relay monitors the current status of the appliances and detects critical and emergency states
- permanent power supply 24–240 V AC
- 1-MODUL, DIN rail mounting
- technical parameters see Page 30



Protection against flooding, level control

Flooding a room is one of the most common domestic accidents that you can easily avoid.

The wireless flood detector monitors for any leakage from your washing machine or dishwasher and warns you in timely fashion of any unwanted water leakage in the bathroom, kitchen, or cellar. If water is detected, you will be alerted by notifications on your smartphone or the ELKO Cloud Report. A universal float sensor or FP-1 external flood probe can be used to monitor the level and give early warning of critical values. Using a flood probe, it is possible to detect, for example, filling the sump while the float sensor reports the filling of the water or other liquid reservoir.



Flood detector

AirSF-100

- activation occurs after flooding the bottom contacts on the detector
- sound and vibration signalling
- battery power
- IP68 enclosure
- technical parametres see Page 33



Level control

AirIM-100

- monitor the current level of liquid
- warns against critical values in time
- IP65 enclosure (Protection against water, dust, ...)
- only one sensor can be connected to the AirIM
- technical parameters see Page 26

Examples of use:

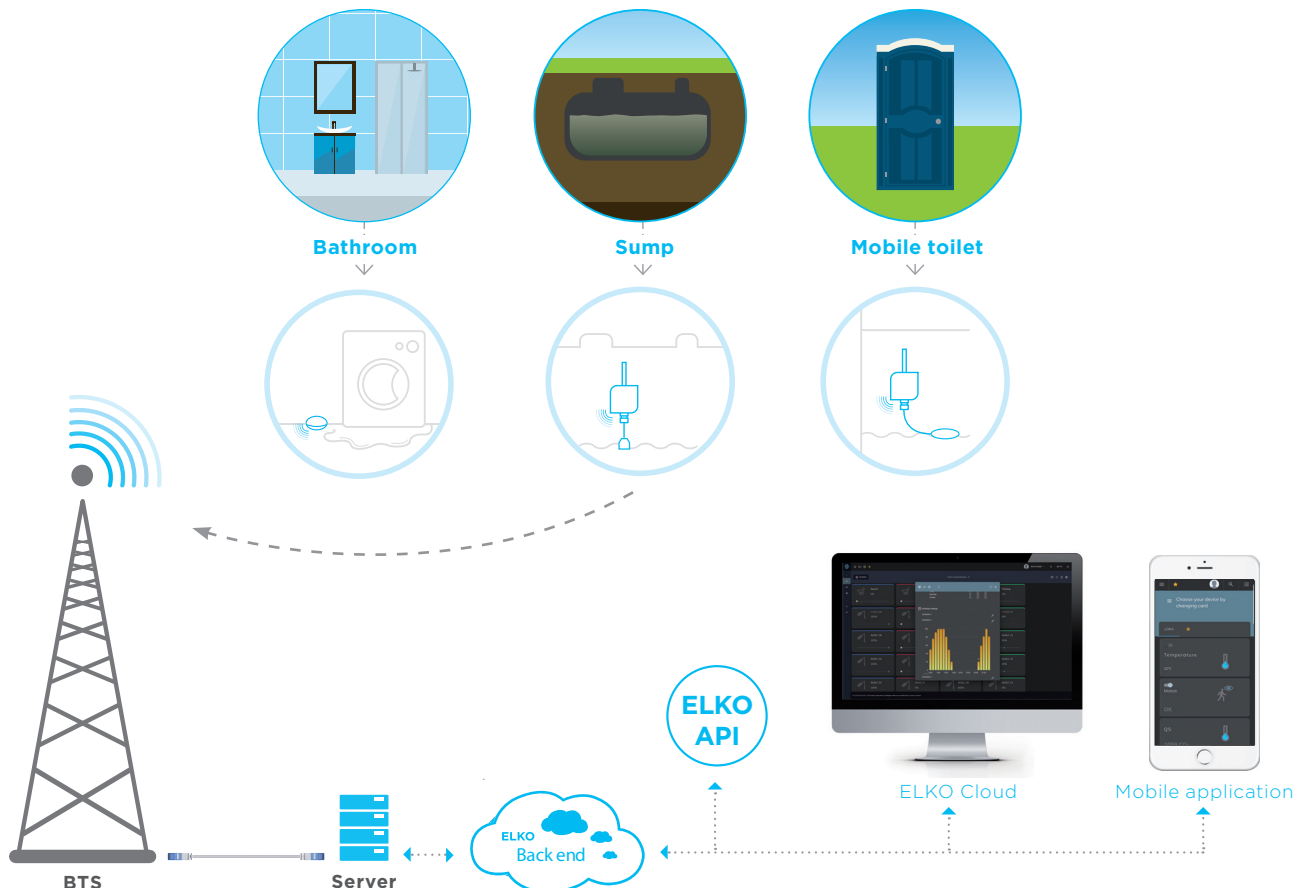

Moving, relocation, opening...

Windows and doors are an easy target for uninvited visitors, so it's good to have everything under control.

The detector consists of two parts – the main housing and magnetic. The main housing enables all communication and monitors the position of the magnet in the magnetic part. The alarm will be triggered when the magnet is removed from the main housing.

Although the detector is primarily designed for windows and doors in remote buildings, cellars, or substations, it can also be used to monitor movable property (cover, street furniture) or when you want to know that inventory is moving.



Magnetic detector (indoor)

AirWD-100

- activation occurs by removing the magnet from the sensor
- for indoor use
- status is displayed in a smartphone application or ELKO Cloud
- battery power
- technical parameters see Page 34



Magnetic detector (outdoor)

AirWD-101

- activation occurs by removing the magnet from the sensor
- for outdoor use, encapsulated
- status is displayed in a smartphone application or ELKO Cloud
- battery power
- technical parameters see Page 35



Examples of use:

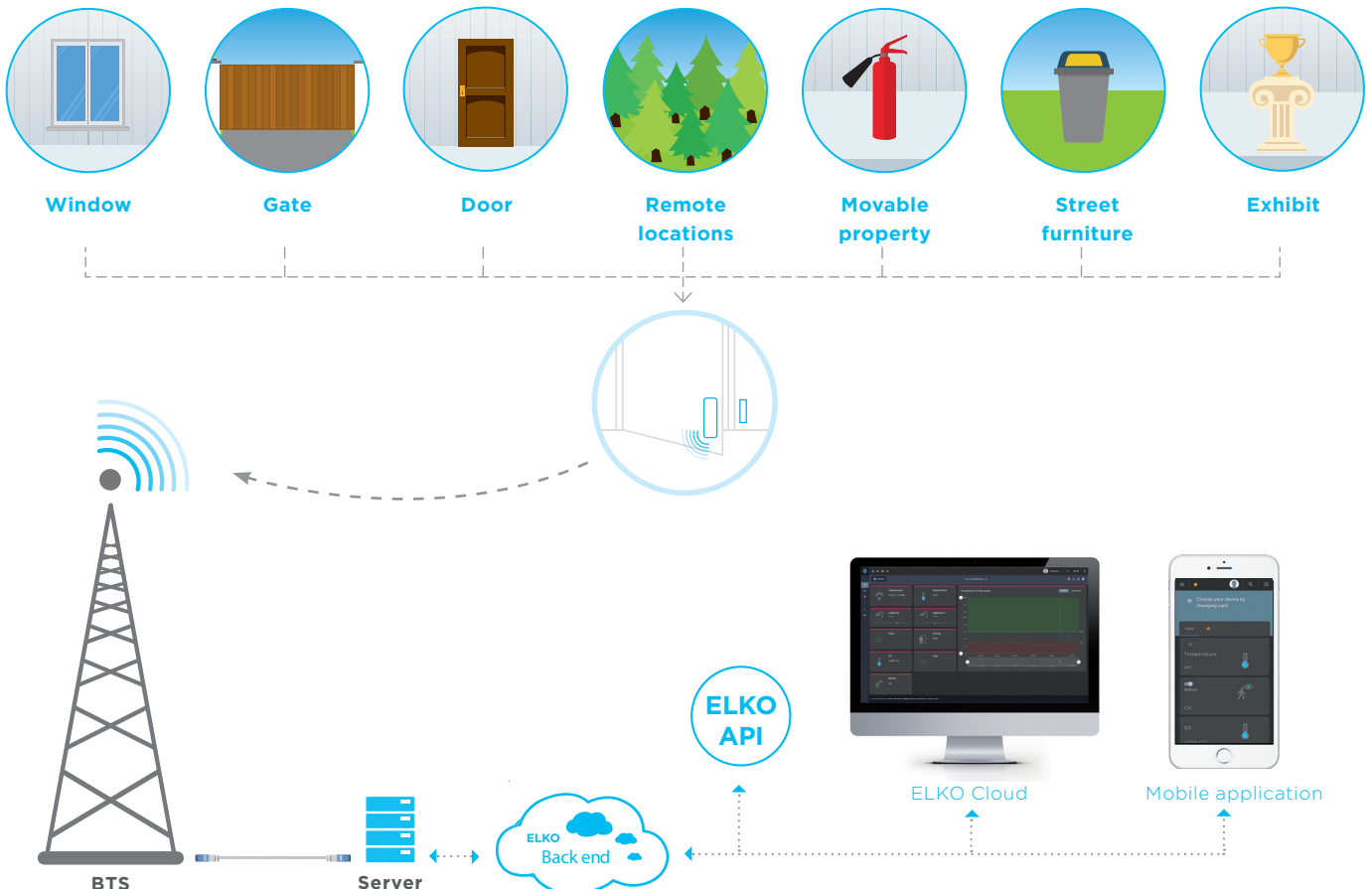

Motion detection

Keep control before the intrusion of strangers and cottages, barns, for example, the substation which you look into once in a while.

The motion detector will guard these areas for you. Using a keychain, you simply unlock these areas when you are present, and when you exit you use the keychain again to activate the detector. In addition, one detector can be paired with multiple key chains, so all members of your family or authorized person can have their own keychain.



Motion detector (indoor)

AirMD-100

- detects people moving in a supervised area
- sensitivity adjustment
- battery power
- technical parameters see Page 32



AirMD

AirKey

Mini alarm

Motion detector & AirKey

- used to activate and deactivate the motion detector at the moment you leave or enter the guarded area
- acoustic signalization informs the user when AirKey is activated or deactivated
- technical parameters see Page 53

Examples of use:

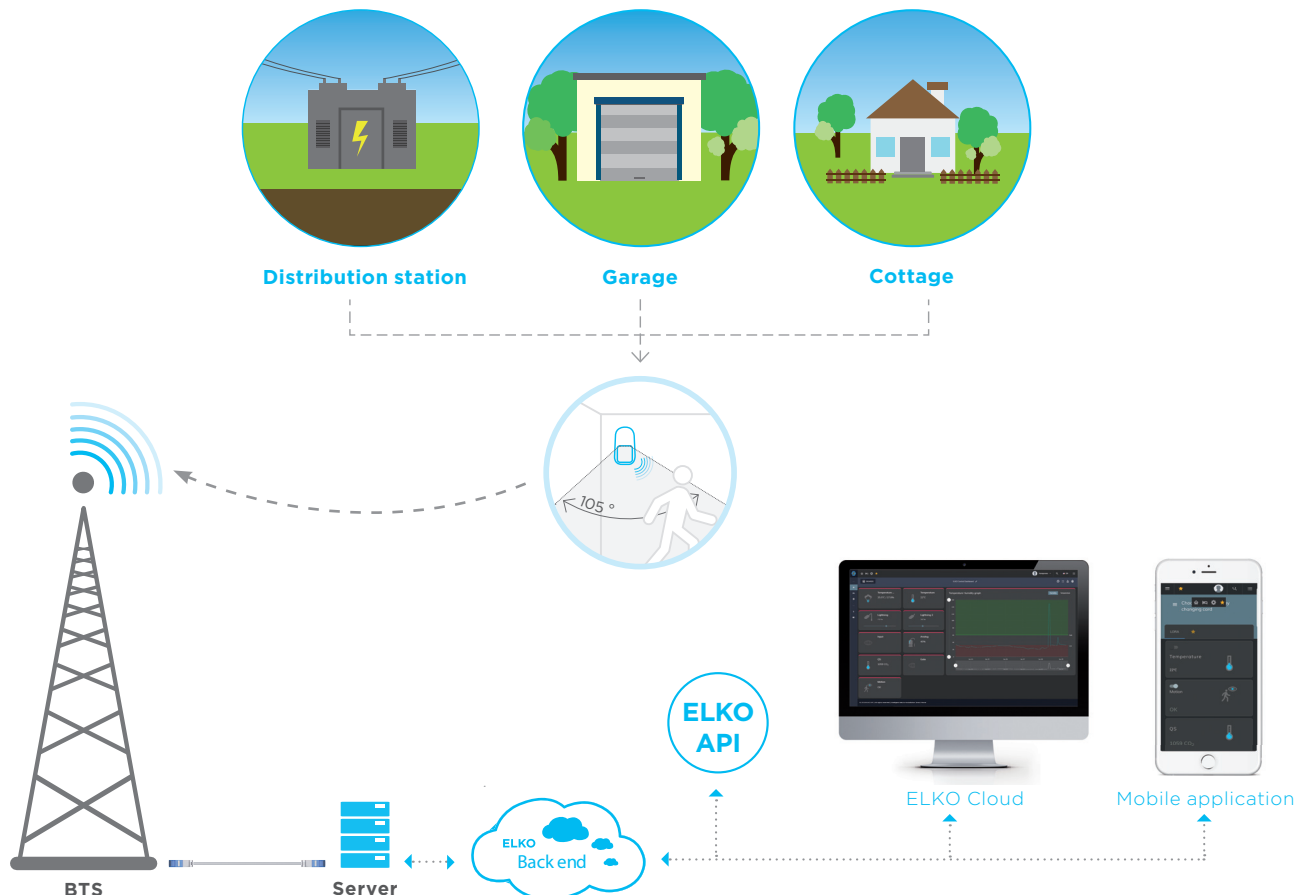

Detecting presence of smoke

The kitchen and living room are the two most frequently used room in which are also the most appliances. Therefore, it is natural to have these rooms protected from any resulting fire.

The smoke detector alerts to any emerging fire, allowing you to respond and protect not only the people in the area but also property in a timely manner.

After the smoke detection of an emerging fire, it instantly transmits this information to Server. Therefore, its use also plays an important role in monitoring remote areas, such as free-standing garages, barns or power stations,.



Smoke detector

AirSD-100

- smoke detection in the result of fire
- automatic testing of functionality
- when smoke is detected the alarm sounds and (LED) lights
- battery power 4x AA
- technical parameters see Page 36



Examples of use:

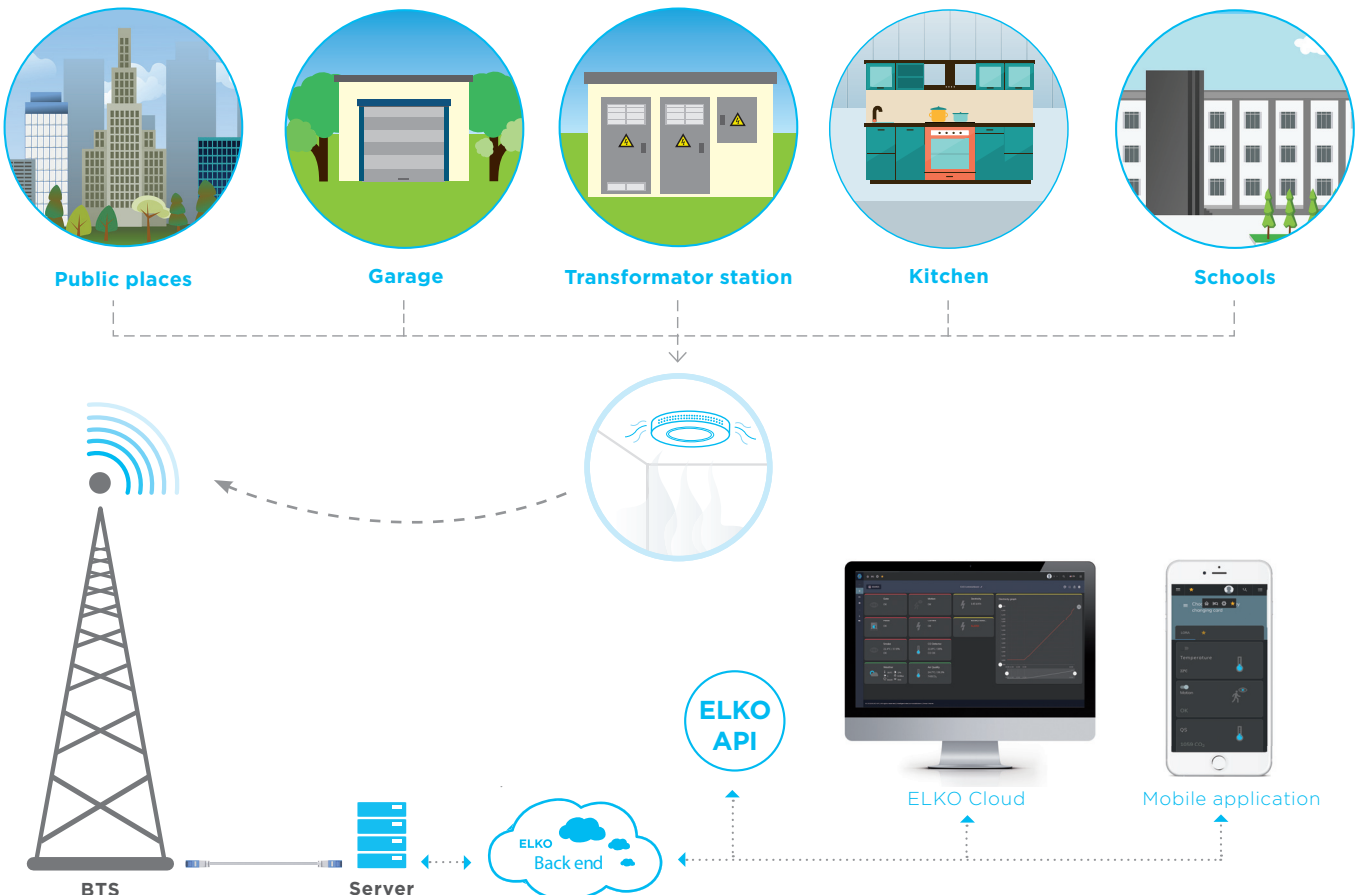

Surrounding Air quality

Impurities in the air are among one of the basic environmental problems. Some substances also have a negative effect on human beings.

Even one person in a poorly ventilated room, by breathing, will soon increase the carbon dioxide (CO₂) concentration to a detrimental level. Higher concentrations can cause headache, affect the ability to concentrate, drowsiness, or worse.

Conversely, carbon monoxide (CO) is produced by incomplete combustion and is very dangerous for human beings. This gas is also produced by cigarettes or aromatic rods.

Our sensors will allow you to easily measure these concentrations and react to an undesirable amount in a timely manner. They can also be part of a master system.

Examples of use:

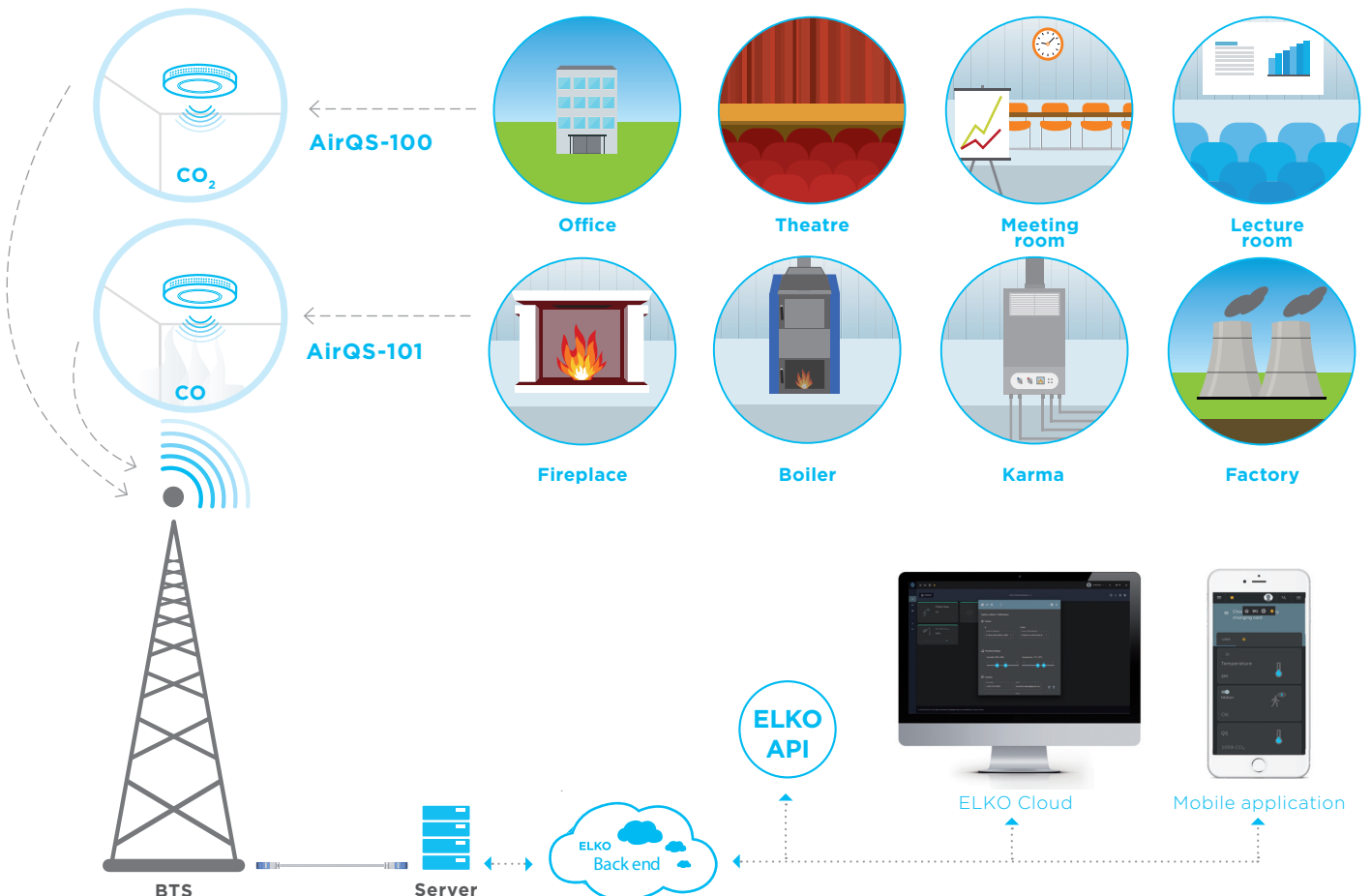

Air quality sensor
- carbon dioxide (CO₂)

AirQS-100

- measurement of the concentration of CO₂ which, in large quantities, can cause headache, affect the ability to concentrate, drowsiness, or worse
- information about actual temperature and humidity
- automatic testing of functionality
- data are sent to the server and displayed in a smartphone application or ELKO Cloud
- permanent powersupply 110-240V AC/DC
- technical parameters see Page 38



Air quality sensor
- carbon monoxide (CO)

AirQS-101

- a security component for monitoring the CO concentration resulting from incomplete combustion
- information about actual temperature and humidity
- data are sent to the server and displayed in a smartphone application or ELKO Cloud
- battery power, 4x AA
- technical parameters see Page 40



Measurement and monitoring of energy

Monitoring of energy due to the ever increasing cost is among the important aspects of every object or property.

Wireless sensors are installed directly on to the water meter, gas meter and electrical meter without damaging their seals. The pulses of these meters are counted and sent as data to the ELKO Backend, where they are further processed and evaluated. In ELKO Cloud it is possible to set notifications when the set parameters are exceeded, so called "threshold".



Pulse transmitter

AirTM-100

- a wireless pulse transmitter designed to scan data (pulse) from energy meters
- data are sent to the server and displayed in a smartphone application or ELKO Cloud
- battery power
- in IP65 enclosure (protection dust, ...)
- technical parametres see Page 28



Supported sensors

- LS - LED sensor
- MS, WS - magnetic sensor
- SO - pulse output
- technical parametres see Page 55

Examples of use:

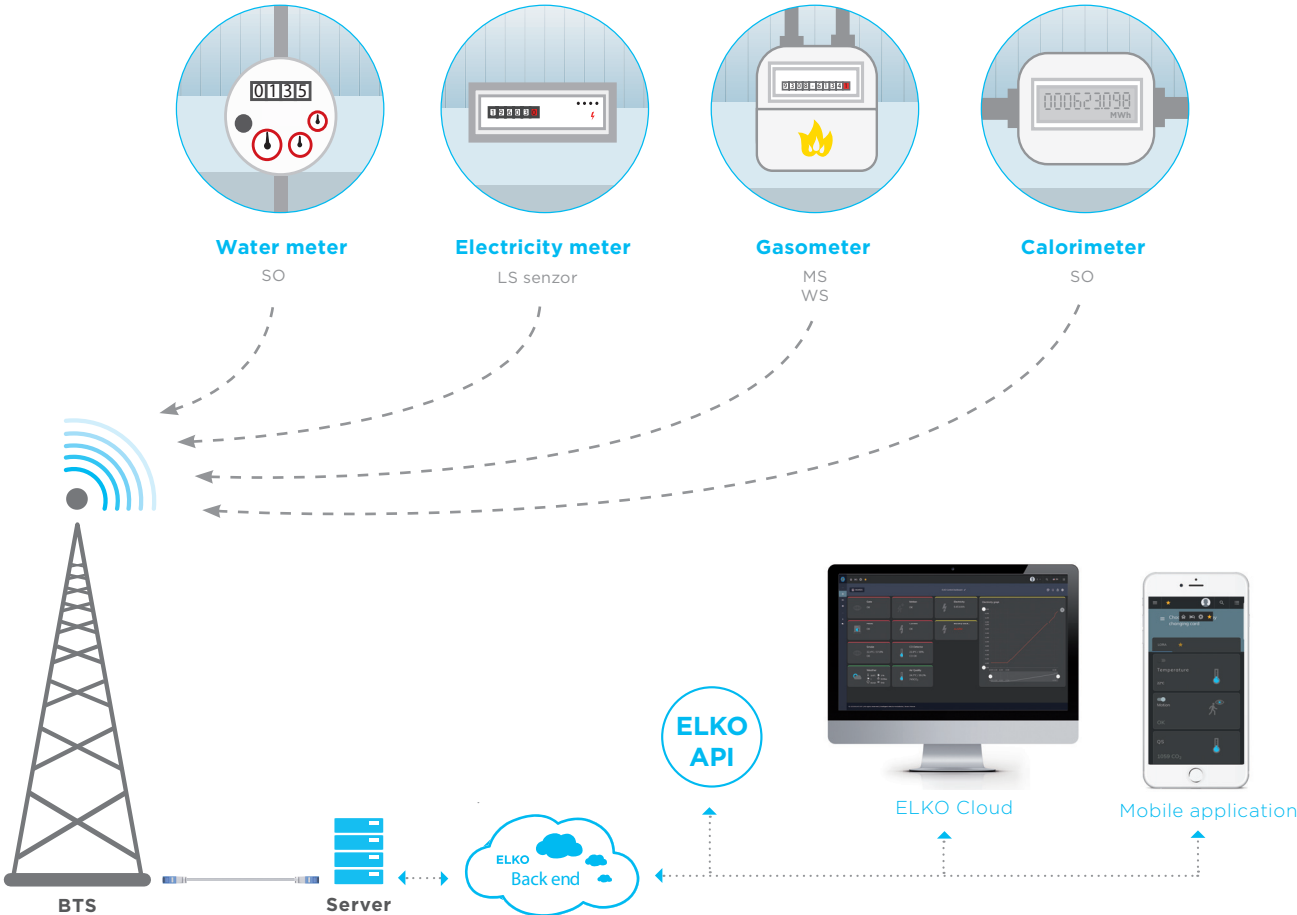

Waste management

The primary idea of smart waste management is to streamline waste administration with the help of modern technologies and to directly reduce the costs of collection and disposal.

Ultrasound scans the “level” of the waste, and over the IoT wireless network it regularly transfers this information to the Server.

Battery power allows for up to 5 years of operation. The entire sensor is located in an anti-vandal box. The filled volume of the container can be viewed via the platform on-line, in a clear map background with color-coded icons. Builtin artificial intelligence, collection history, and current period can predict the requirement for emptying. In this way, containers of recyclable secondary raw materials (paper, glass, PET) can also be monitored.



Ultrasonic fill-level*

AirWS-100

- the ultrasonic sensor measures the level of filling
- it is usually placed on the lid or top of the container and informs the user of the level of filling - e.g. by waste
- this information is used for efficient waste collection planning or for use in other industries when planning tasks related to, for example, logistics
- temperature sensor informs about temperature in waste container
- built-in sensor for opening the lid or for tipping over the waste container
- battery power with a lifetime of about 8 years
- IP65 protection
- technical parameters see Page 49



* Detector AirWS-100 can be used to detect free capacity of grain elevator, water tank level, etc.

Examples of use:

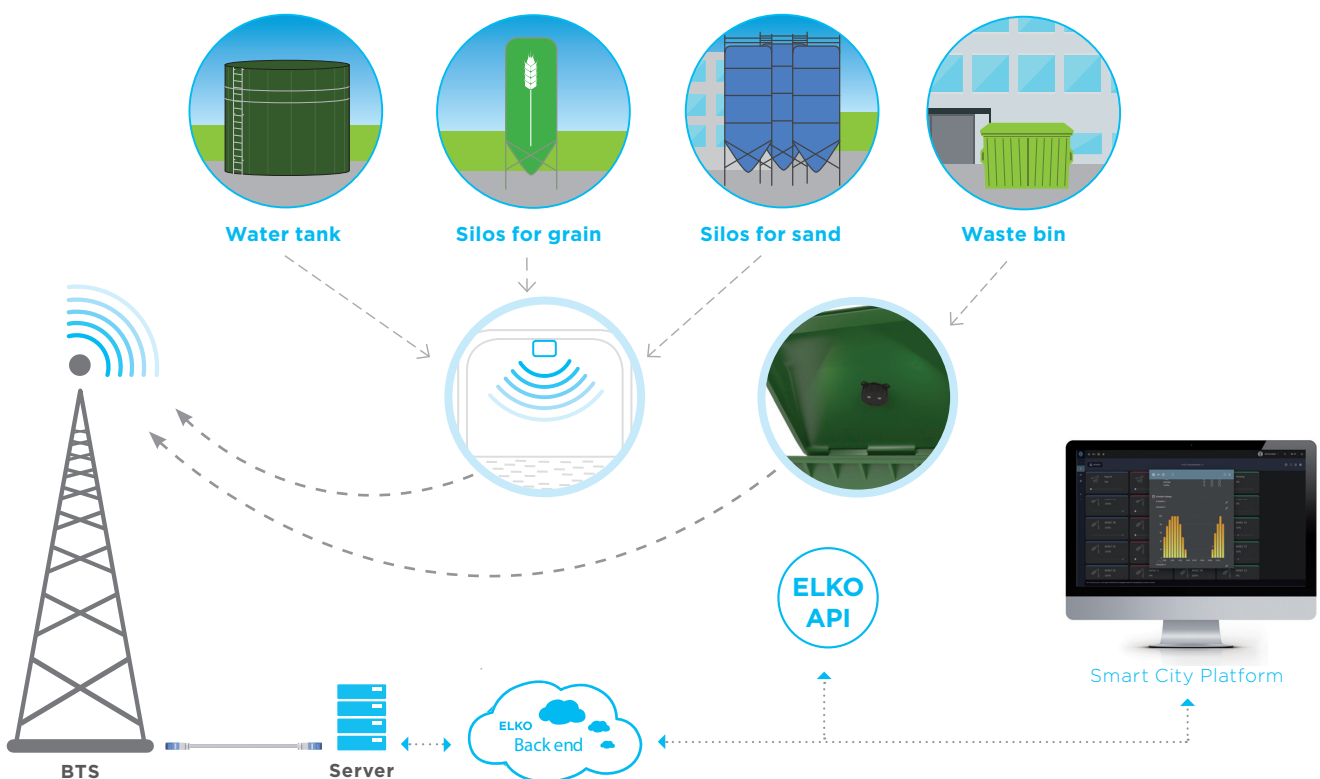

Smart parking

Finding a free parking space in today's crowded cities is almost a miracle...

A total of 20% of drivers in urban traffic are just looking for a place to park. However, their cars cannot easily reach free spaces. The solution is to install parking sensors that use state-of-the-art technology. In conjunction with the service application, you have a solution that will free the streets of your city. Sensors located on individual parking spaces detect occupancy; the application navigates cars to vacancies, and in the case of charging customers can also pay parking fees. The installation of sensors is simple; it takes about 20 minutes with the necessary equipment. Our parking sensors can be used in corporate parking lots, car parks at department stores or administrative complexes.



Parking detector

AirPD-100

- detects a free or occupied parking space, using measurements based on magnetic field sensing
- data are sent to the server and displayed in a smartphone application or ELKO Cloud
- battery power with a lifetime of about 10 years
- enhanced IP67 protection
- technical parameters see Page 48



Examples of use:

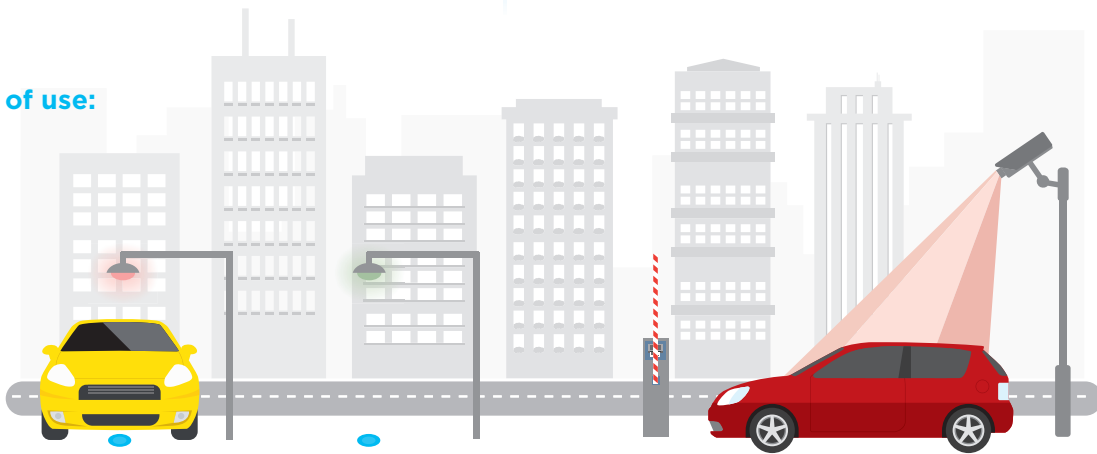

Smart parking

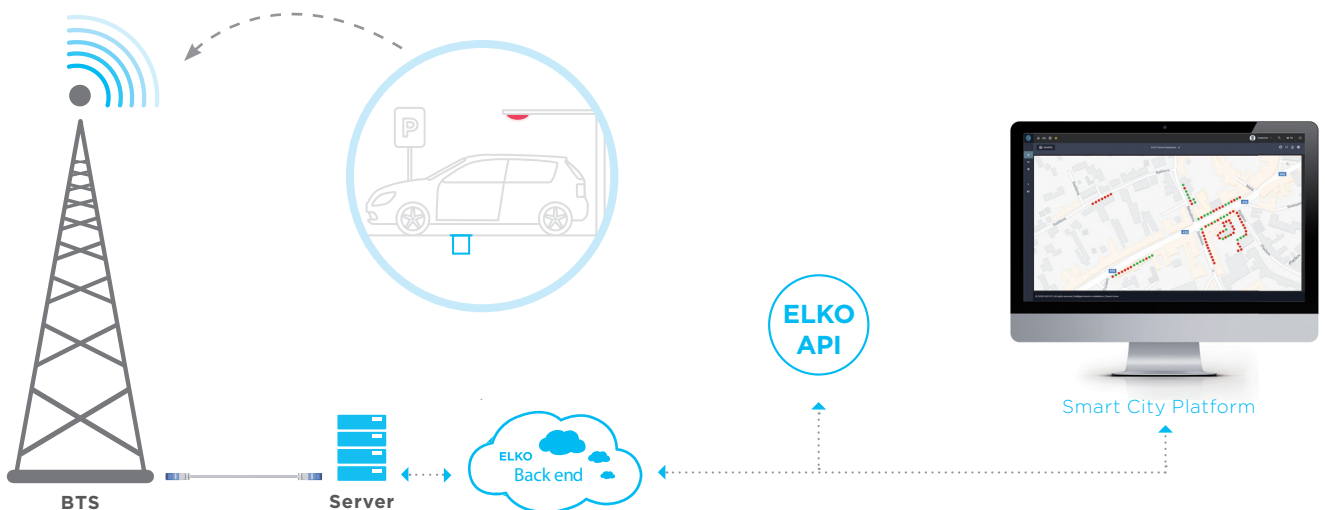

Smart street lighting

Smart public lighting is environmentally friendly, as well as being kind to your wallet.

Replacing existing light sources with modern LED lights combined with intelligent control makes it possible to reduce the cost of electricity consumption by up to 80%. Thanks to the LoRa's modern network of communications, the lights can be controlled from up to 20 km. In addition to switching on and off, it is possible to control the intensity of lighting and also to diagnose a light defect. Using an oscilloscope, it can respond to ambient conditions. The component for public lighting simply attaches to the light or the mast and is immediately operational. Control can be performed from the control room by using cloud applications, in the field by tablet or smartphone.

Retrofit modul



Outdoor design for retrofits, placement externally on the body of the light, mast or base.

PLUG-IN (socket)

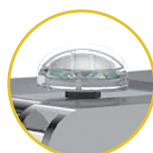

Receiver actuator in a special box with a bayonet connector for easy installation into lights equipped with this socket.

OEM (built-in) - Embedded

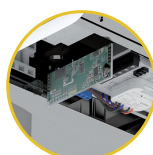
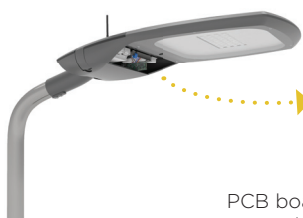

PCB board for direct integration into the power supply board.



Twilight sensor

AirSOU-100

- allows you to capture the current natural light intensity, and with this information control the intensity of artificial lighting, thereby reducing power consumption
- battery power
- enhanced IP65 protection (dust and splash protection)
- technical parameters see Page 47



Retrofit modul

AirSLC-100

- a component for switching public lighting in a city, area, car park
- data are displayed in a smartphone application or Cloud
- permanent power supply 110–230 V AC
- in IP65 enclosure (Protection against water, dust, ...)
- output: DALI or 0-10 V
- technical parameters see Page 46



Plug-in (socket)

AirSLC-100/LWES, AirSLC-100/NEMA



- two standards:
4 pins - LUMAWISE ENDURANCE S.
7 pins - NEMA
- „hat“ is according to the type of luminaire on the bottom or top
- output: DALI or 0-10 V
- technical parameters see Page 42-45



OEM (built-in) - Embedded

LoRaWAN Modul OEM

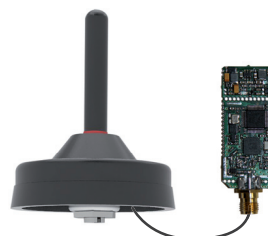

- Connection: soldering pins
- Power supply: 5-24VDC, after breaking source parts only stabilized 3V3 / 140mAh
- Communication:
- SPI 1x
- Analog pins 8x (12-bit)
- USART 1x
- I / O digital pins 29x
- Gain: + 2,12 dB
- Communication: LoRa 868Mhz
- Antenna: external ULF or SMA connector, internal bent parts of the product
- technical parameters see Page 52





Industrial area

Examples of use:

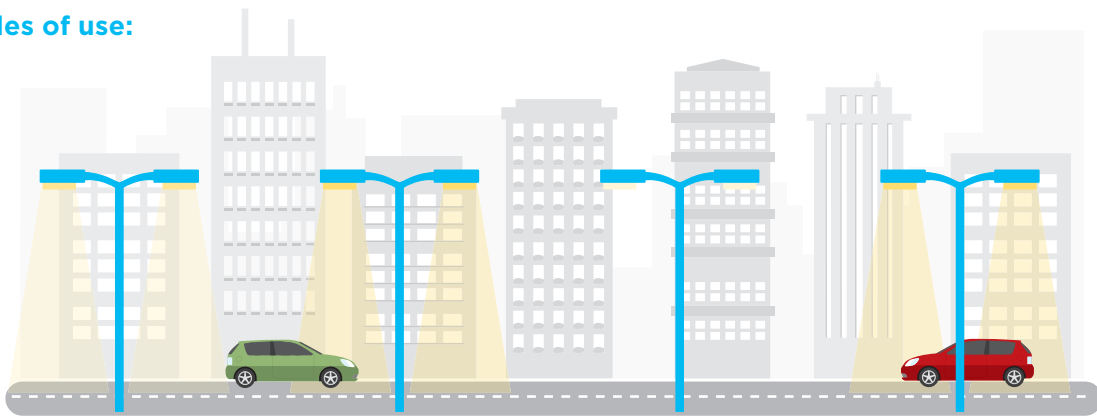

Controlled dimming of lights

Maintain a constant light intensity in a given area is for many of us a tough challenge...

Using the dimming light sensor, you can simply capture data relating to the natural light and respond to it by utilising artificial lighting control, which also reduces electricity consumption. Thanks to its enhanced coverage and battery power, it can also be placed in outdoor areas and used in both residential and commercial projects - production or storage halls or greenhouses. You can also use the unit as the main component which can control a whole group of luminaires using the measured data.



Twilight sensor

AirSOU-100

- allows you to capture the current natural light intensity, and with this information control the intensity of artificial lighting, thereby reducing power consumption
- battery power
- enhanced IP65 protection (dust and splash protection)
- technical parameters see Page 47



Examples of use:

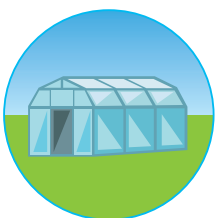

Greenhouse

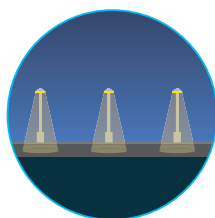

Public lighting

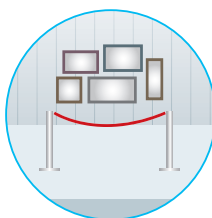

Exhibition grounds

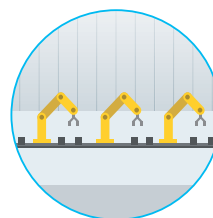

Production hall



Storage hall

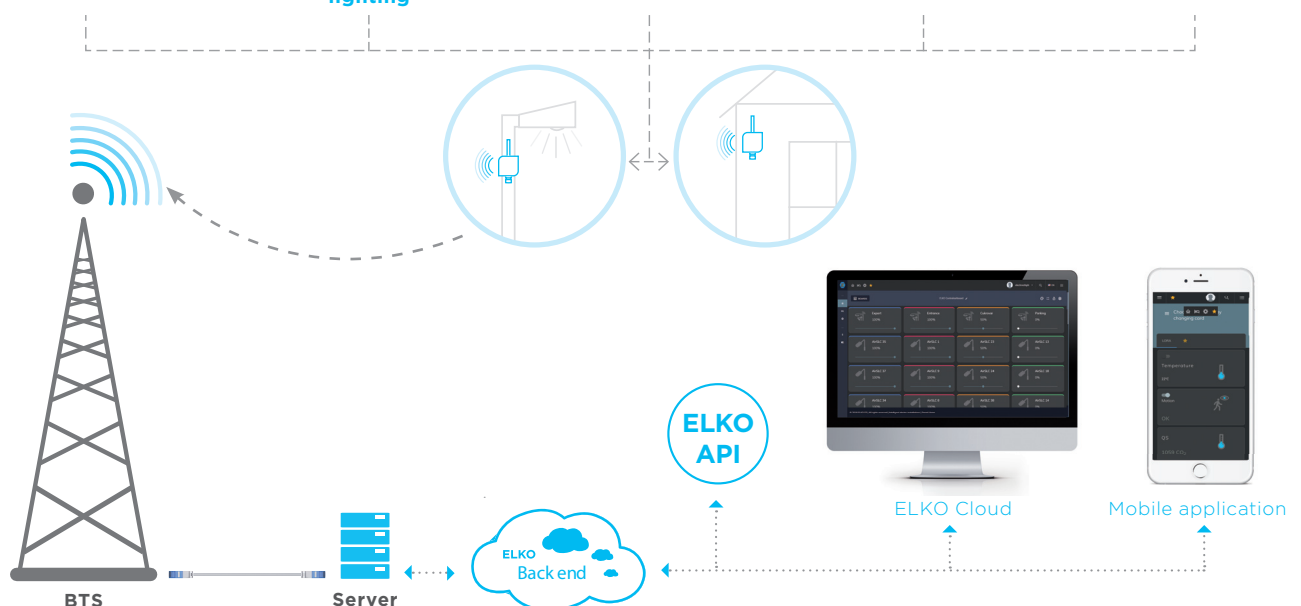

Movables security

To secure movables placed outside perfectly against theft is almost impossible if this is mean of transport, machine, harvest in form of straw bale or roundwood.

Gyroscopic detector reacts on any position change and therefore it can notify the user of unauthorized manipulation of secured movables. It delivers also an immediate feedback about position change, so user can take action against thief or vandal in time. Detector transmits immediately the information in form of notification, text and also in your ELKO Cloud after recorded position change. Detector can be used in several cases – depending on customer choice or invention.



Gyroscopic detector

AirGYRO-100L, AirGYRO-100NB

- responds to changing its location
- sends a message to the server when it is detected
- Battery power
- Enhanced IP65 protection (dust and splash protection)



Examples of use:



Stored logs



Beehives

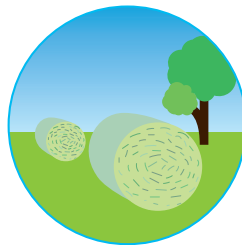

Stored hay



Vehicles



Traffic lights



ELKO API

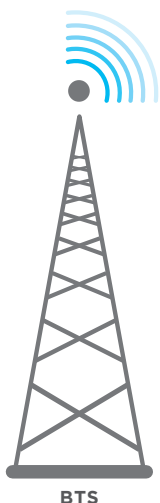

Server



ELKO API

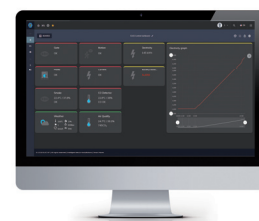

ELKO Cloud

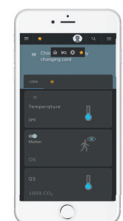

Mobile application



Content

AirIM-100 Universal input	26
AirTM-100 Pulse converter	28
AirIM-100/M Universal input (for DIN rail)	30
AirMD-100 Motion detector	32
AirSF-100 Flood detector	33
AirWD-100 Magnetic detector (indoor)	34
AirWD-101 Magnetic detector (outdoor)	35
AirSD-100 Smoke detector	36
AirQS-100 Air quality sensor - carbon dioxide (CO ₂)	38
AirQS-101 Air quality sensor - carbon monoxide (CO)	40
AirSLC-100/LWES Street light controller - LUMAWISE plug	42
AirSLC-100/NEMA Street light controller - NEMA socket	44
AirSLC-100 Street light controller	46
AirSOU-100 Twilight sensor	47
AirPD-100 Parking detector	48
AirWS-100 Ultrasonic fill-level sensor	49
AirGTW-FWD LoRa Gateway FWD for LoRaWAN networks	50
AirGTW-LNS LoRa Gateway LNS for LoRaWAN networks	51
LoRaWAN Modul OEM Built-in board	52
 Accessories	
AIR KEY Key chain iNELS Air	53
RFAF/USB Service Key	53
TC, TZ Thermo sensors	54
HTML2500LF Temperature and humidity sensor	54
LS, MS, WS Sensors	55
AN-I Internal antenna	55
AN-E External antenna	55
FP-1 Flood probe	55

AirIM-100 | Universal input



Technical parameters	AirIM-100S	AirIM-100L	AirIM-100NB
Power supply			
Battery power:	1x 3.6V LS 14500 Li-SOCl ₂ AA		
Battery life:	max. 5 years	max. 3 years (depending on the frequency of use)	
External power supply:	5 – 12V DC (on terminal)		
Supply voltage tolerance:	+10 %; -15%		
Standby consumption:	0.2 mW		
Transmitting power consumption:	250 mW	150 mW	850 mW
Setting			
Setting:	With a message from the server using setting pins, SET button, programming cable		
Alarm Detection:	message to the server		
Battery status view:	only when the battery is powered by a message on the server		
Control			
Control:	button SET Magnetic contact Tamper		
Analog inputs			
Thermal:	TC / TZ*		
Voltage:	AIN 0(1) - 10 V		
Current:	AIN 0(4) - 20 mA		
Battery measurement:	12 V/24 V		
Flooding:	Flood probe*		
Digital inputs			
Inputs:	IN1, IN2		
Supported sensors for energy measurements:	LS (LED sensor)* MS, WS (magnetic sensor)* SO (Contact, open collector)		
Detection of the magnet sensor			
Closed:	< 1.5 cm		
Open:	> 2 cm		
Reliability:	99.9 %		
Other supported sensors			
Flood probe:	FP-1*		
Tempe. and humidity measurement:	HTM2500LF*		
Temperature measurement range			
Thermo sensor TC:	0 .. 70 °C		
Thermo sensor TZ:	-40 .. 125 °C		
Sensor HTM2500LF:	-40 .. 85 °C		
Communication			
Protocol:	Sigfox	LoRa	NB-IoT
Transmitter frequency:	RCZ1 868 MHz	868 MHz	LTE Cat NB1**
Range in open space:	Approx. 50 km***	Approx. 10 km***	Approx. 30 km***
Transmission power (max.):	25 mW / 14 dBm	25 mW / 14 dBm	200 mW / 23 dBm

- The Universal input is used to detect device statuses which ensure the smooth and trouble-free operation both in the residential and industrial sectors.
- The Universal input has a pulse, analog, binary input and terminals for connecting the temperature sensor.
- In conjunction with the sensor it is used, for example, for monitoring the level, temperature, gas, water or electricity, flooding...
- It provides a quick solution to learn about the critical condition of your device which you can immediately respond to (e.g. service interference).
- Using the universal sensor will help you eliminate financial losses caused by device malfunctions, or report the need for action in advance.
- For each power meter it is necessary to have one Universal input AirIM-100.
- With the wireless solution and Sigfox / LoRa / NB-IoT communication, it can communicate instantly to your chosen location and be operated immediately.
- Data is sent to the server from which it can be subsequently displayed as a smartphone, application, or Cloud notification
- Anti-sabotage: If access to the device is unauthorized, a message is immediately sent to the server.
- Anti-sabotage: When a cover is removed, a message is sent to the application or ELKO Cloud.
- Power supply: 5-12 V DC or 1x 3.6 V batteries SAFT with approx. 5 years (depending on the frequency of use)
- In the case of external power, the battery is automatically disconnected and serves as backup power.
- Protection degree IP65.

Device description

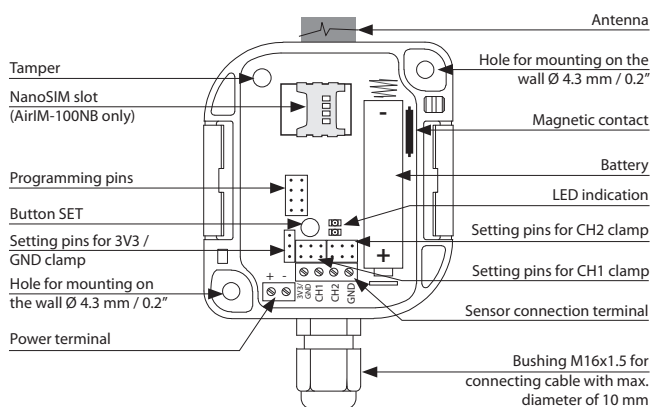

Other parameters	
Working temperature:	-30...+60°C (Pay attention to the operating temperature of batteries)****
Storage temperature:	-30...+70°C
Operating position:	any
Mounting:	glue / screws
Protection degree:	IP65
Connecting External Power:	terminals, wires 0.5 – 1 mm ²
Connection of the sensor:	terminals, wires 0.5 – 1 mm ²
Cable grommet:	M16 x 1.5 for cable Ø max. 10 mm
Dimension:	182 x 62 x 34 mm
Weight:	108 g (without battery)

* Not included in the package

** Multiple frequency bands of B1 / B3 / B5 / B8 / B20 / B28

*** Depending on network coverage

**** Pay attention to the operating temperature of batteries -60...+85 °C

Function

1. **S0** - pulse counting S0
Recommended accessories: cable for S0 output
2. **Energy measurement** - pulse counting from active sensor LS, MS, WS
Recommended accessories
 - LS (LED sensor): is particularly suitable for power meters that support LED pulse sensing
 - MS (magnetic sensor): is particularly suitable for gas meters that support magnetic sensing.
 - WS (magnetic sensor for water meter): it is particularly suitable for water meters that support magnetic sensing.
3. **Flood Detection** - Flood Sensor
Recommended accessories: flood sensor FP-1
4. **Opening detection** - Window / Door Magnetic Sensor (integrated inside the unit)
Recommended accessories: Magnet D / WD
Note: The universal sensor has a magnet sensor located only on one side, so be careful about the correct position relative to the magnet.
5. **Analog measurement. Voltage 0 - 10 V**
6. **Analog measurement. Current 0 - 20 mA**
7. **Battery measurement 12/24 V** - voltage measurement 0 - 24V
8. **Temperature measurement**
Recommended accessories: TC or TZ temperature sensor
9. **HTM2500LF** - Temperature and Humidity Sensor Measurement HTM2500LF
Recommended accessories: HTM2500LF sensor
10. **Alarm function** - check the contact

Sigfox Ready Certification



Certificate ID for AirIM-100S Universal Sensor:
P_0094_56EE_01

AirTM-100 | Pulse converter



Technical parameters	AirTM-100S	AirTM-100L	AirTM-100NB
Power supply			
Battery power:	1x 3.6V LS 14500 Li-SOCl ₂ AA		
Battery life:	max. 5 years	max. 3 years (depending on the frequency of use)	
External power supply:	5 – 12V DC (on terminal)		
Supply voltage tolerance:	+10 %; -15%		
Standby consumption:	0.2 mW		
Transmitting power consumption:	250 mW	150 mW	850 mW
Setting			
Setting:	With a message from the server using setting pins, SET button, programming cable		
Alarm Detection:	message to the server		
Battery status view:	only when the battery is powered by a message on the server		
Control			
Control:	button SET Tamper		
Communication			
Protocol:	Sigfox	LoRa	NB-IoT
Transmitter frequency:	RCZ1 868 MHz	868 MHz	LTE Cat NB1 *
Range in open space:	Approx. 50 km**	Approx. 10 km**	Approx. 30 km**
Transmission power (max.):	25 mW / 14 dBm	25 mW / 14 dBm	200 mW / 23 dBm
Other parameters			
Working temperature:	-30...+60°C (Pay attention to the operating temperature of batteries)***		
Storage temperature:	-30...+70°C		
Operating position:	any		
Mounting:	glue / screws		
Protection degree:	IP65		
Connecting External Power:	terminals, wires 0.5 – 1 mm ²		
Connection of the sensor:	terminals, wires 0.5 – 1 mm ²		
Cable gommet:	M16 x 1.5 for cable ø max. 10 mm		
Dimension:	182 x 62 x 34 mm		
Weight:	100 g (without battery)		

- The Pulse converter counting quantities of pulses from the energy meters (electricity, water, gas).
- The Pulse converter is designed for use on existing gauges even without impulse output „50“ (gauge must support sensing).
- AirTM-100 converts gauge consumption using sensors - LS (LED sensor), WS (magnetic sensor for water meter), MS (magnetic sensor) or pulse output.
- For each power meter it is necessary to have one Pulse converter AirTM-100.
- With the wireless solution and Sigfox / LoRa / NB-IoT communication, it can communicate instantly to your chosen location and be operated immediately.
- Data is sent to the server from which it can be subsequently displayed as a smartphone, application, or Cloud notification
- Anti-sabotage: If access to the device is unauthorized, a message is immediately sent to the server.
- Power supply: 5-12 V DC or 1x 3.6 V batteries SAFT with approx. 5 years (depending on the frequency of use).
- In the case of external power, the battery is automatically disconnected and serves as backup power.
- Protection degree IP65.

Device description

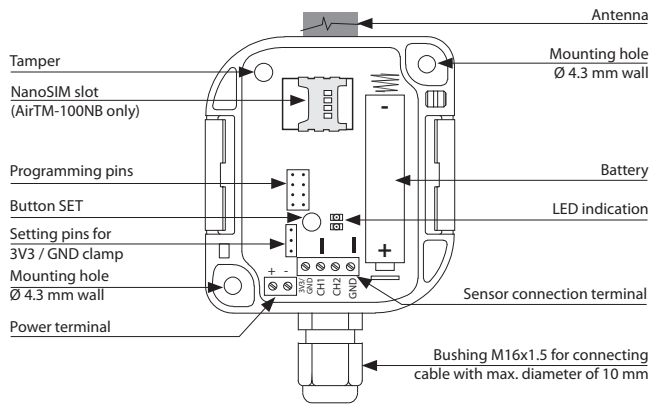

* Multiple frequency bands of B1 / B3 / B5 / B8 / B20 / B28

** Depending on network coverage

*** Pay attention to the operating temperature of batteries -60...+85 °C

Function

1. S0 - pulse counting S0
Recommended accessories: cable for S0 output
2. **Energy measurement** - pulse counting from active sensor LS, MS, WS
Recommended accessories
 - LS (LED sensor): is particularly suitable for power meters that support LED pulse sensing
 - MS (magnetic sensor): is particularly suitable for gas meters that support magnetic sensing.
 - WS (magnetic sensor for water meter): it is particularly suitable for water meters that support magnetic sensing.

Sigfox Ready Certification



Certification ID for AirTM-100S Pulse Transmitter:
P_0094_B301_01

AirIM-100/M | Universal input (for DIN rail)



- In conjunction with the output contact of the respective monitoring relay, it serves to monitor voltage, current or levels.
- Using a universal feature provides a quick solution to keep track of the current status of the supervised equipment or technology unit and eliminates the financial loss caused by the malfunction of the device
- Communication on the Sigfox or LoRa network.
- Data is sent to the server from which it can be subsequently displayed as a smartphone, application, or Cloud notification.
- Li-Ion battery pack for 24 hour backup.
- The package includes an internal antenna AN-I, in case of locating the converter in a metal switchboard, you can use the external antenna AN-E for better signal reception.
- 1-MODULE, DIN rail mounting.

Technical parameters	AirIM-100S/M	AirIM-100L/M
Supply voltage:	85 - 230 V AC (50 - 60 Hz)	85 - 230 V AC (50 - 60 Hz)
Supply voltage tolerance:	+10 % / -25 %	
Input:	3 VA	
Backup power:	battery Li-Ion	
Battery life:	24 hour	
Battery charging:	7 hour	
Setting		
Setting:	With a message from the server / button SET	
Alarm Detection:	message to the server	
Battery status view:	only when the battery is powered by a message on the server	
Indication		
- red LED:	broadcast / D1	
- green LED:	power supply / D2	
- without indication:	Backup battery power / no power	
Input		
Digital input:	D1, D2	
Supported sensors for energy measurements:	LS (LED sensor)* MS, WS (magnetic sensor)* SO (Contact, open collector)	
Communication		
Protocol:	Sigfox	LoRa
Transmitter frequency:	RCZ1 868 MHz	868 MHz
Range in open space:	Approx. 50 km**	Approx. 10 km**
Transmission power (max.):	25 mW / 14 dBm	25 mW / 14 dBm
Other parameters		
Working temperature:	-20 ... + 50 °C	
Operation position:	any	
Mounting:	DIN rail EN 60715	
Protection degree:	IP20 from the front panel	
Overvoltage category:	III.	
Pollution degree:	2	
Max. cable size (mm ²):	max. 1x 2.5, max. 2x 1.5 / with a hollow max. 1x 2.5	
Connection of the sensor:	terminals, wires 0.5 - 1 mm ²	
Output for antenna:	SMA connector ***	
Dimension:	90 x 17.6 x 64 mm	
Weight:	93 g	

* Not included in the package.

** Depending on network coverage.

*** Max Tightening Torque for antenna connector is 0.56 Nm.

Device description

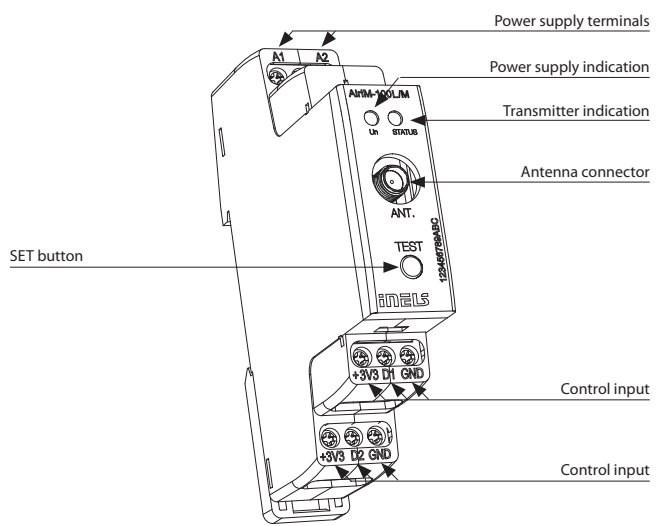

Accessories

A summary and overview of all types of monitoring relays can be found in the technical catalogue **Modular electronic devices**: <https://www.elkoep.com/catalogs-and-brochures>

Function

1. **S0** - pulse counting S0
 - For each channel, a different function can be set independently.
 - Recommended accessories: cable for S0 output
2. **Energy measurement** - pulse counting from active sensor LS, MS, WS
 - For each channel, a different function can be set independently.
 - Recommended accessories
 - LS (LED sensor): is particularly suitable for power meters that support LED pulse sensing
 - MS (magnetic sensor): is particularly suitable for gas meters that support magnetic sensing.
 - WS (magnetic sensor for water meter): it is particularly suitable for water meters that support magnetic sensing.
3. **Flood Detection** - Flood Sensor
 - Recommended accessories: flood sensor FP-1
4. **HTM2500LF** - Temperature and Humidity Sensor Measurement HTM2500LF
 - Recommended accessories: HTM2500LF sensor
5. **Alarm function** - check the contact - switch
 - For each channel, a different function can be set independently.
6. **Alarm function** - check the contact - switch
 - For each channel, a different function can be set independently.
7. **NC function** - this function must be set on an unallocated channel (if only one channel is connected).
 - For each channel, a different function can be set independently.

AirMD-100 | Motion detector



Technical parameters	AirMD-100S	AirMD-100L	AirMD-100NB
Power supply			
Battery power:	battery 2x 1.5V AA		
Battery life:	min. 1 year (according to the frequency of use)		
Setting			
Alarm Detection:	message to the server, audible alarm		
Battery status view:	only when the battery is powered by a message on the server		
Indication			
- blue LED:	motion detected		
Programming:	DIP Switch 3		
Detection angle:	105°		
Detection distance:	max. 12 m		
Recommended working height:	max. 2.2 m		
Communication			
Protocol:	iNELS RF Control		
Transmitter frequency:	868 MHz		
Range in open space:	up to 100m		
Protocol:	Sigfox	LoRa	NB-IoT
Transmitter frequency:	RCZ1 868 MHz	868 MHz	LTE Cat NB1*
Range in open space:	Approx. 50 km**	Approx. 10 km**	Approx. 30 km**
Transmission power (max.):	25 mW / 14 dBm	25 mW / 14 dBm	200 mW / 23 dBm
Other parameters			
Working temperature:	0...+50°C (Pay attention to the operating temperature of batteries)		
Storage temperature:	-30...+70°C		
Operating position:	vertical		
Mounting:	glue / screws		
Protection degree:	IP20		
Color:	white		
Dimension:	46 x 105 x 43 mm		
Weight:	62 g (without battery)		

* Multiple frequency bands of B1 / B3 / B5 / B8 / B20 / B28
 ** Depending on network coverage

- The PIR motion detector is used to detect people moving in the interior.
- PIR sensitivity settings to eliminate unwanted switching.
- The detector offers a quick and comfortable solution for detecting motion in an object. It's just a simple installation at the location.
- The Sigfox, LoRa or NB-IoT network can be used for message transmission.
- Anti-sabotage function (tamper): When unauthorized interference with the detector occurs (disassembly) it sends an information message to the server.
- Data is sent to the server from which it can be subsequently displayed as a smartphone, application, or Cloud notification.
- Battery status information is sent as a message to the server.
- Power supply: battery 2x 1.5 V AA, the battery life is around 1 year, according to the frequency of use.
- The Disarm is done either with a message from the server or by using the AirKey key fob that communicates with the detector wirelessly.

Description

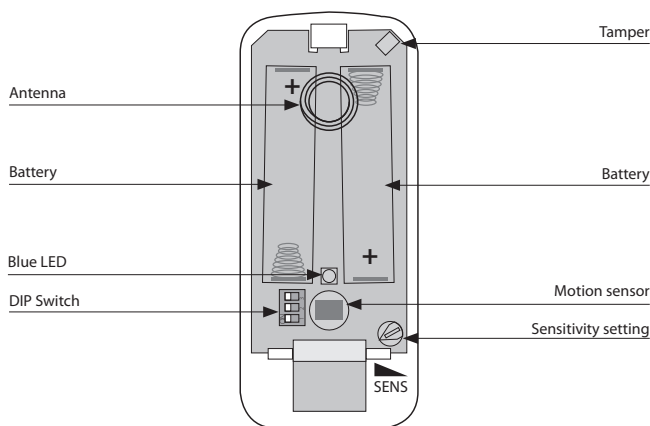

Function

If no movement is detected by the motion detector for 15 minutes, the guard will be activated automatically.

Disarm (DISARM)

When capturing motion in the guard state, the blue LED lights up and an uninterrupted beep sounds at the same time. Press the button on the Air-Key Controller. The audible alarm is switched off and the transition to the DISARM status is confirmed by a short beep.

If the guard is not switched off within 5 seconds, the audible alarm turns off and the detector sends the alarm to the user.

If the detector is deactivated by the AirKey controller, it does not transmit the motion detection information to the user.

Detection field - the detection area is covered by three cones

Top view range

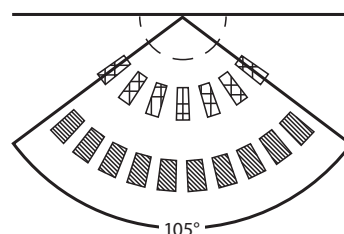

Side view range

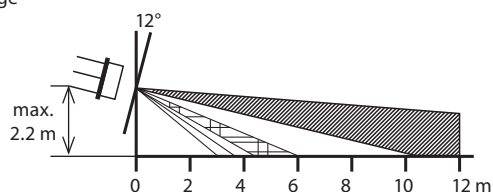



Technical parameters	AirSF-100S	AirSF-100L	AirSF-100NB
Power supply			
Battery power:	1x CR123A battery		
Battery life:	approx. 2 years (depending on frequency of use)		
Setting			
Alarm Detection:	message to the server, vibration, optical and audible alarm		
Battery status view:	message to the server		
DIP switch:	Position 1: turn off sound signal Position 2: turn off mechanical signal Position 3: turn off optical signal		
Acoustic signal:	greater than 85 dB		
Detection			
Sensor:	contacts for flooding		
Detection principle:	contact between the sensor sensed liquid		
Response Time:	2 s after connecting the scanning contacts		
Measurement accuracy:	99.8 %		
Sensitivity:	in the range 0.03 - 20 kΩ		
Indication			
- red LED:	broadcast, alarm		
Communication			
Protocol:	Sigfox	LoRa	NB-IoT
Transmitter frequency:	RCZ1 868 MHz	868 MHz	LTE Cat NB1*
Range in open space:	Approx. 50 km**	Approx. 10 km**	Approx. 30 km**
Transmission power (max.):	25 mW / 14 dBm	25 mW / 14 dBm	200 mW / 23 dBm
Other parameters			
Working temperature:	0...+50°C (Pay attention to the operating temperature of batteries)		
Storage temperature:	-30...+70°C		
Operation position:	capture contacts for flooding downwards		
Mounting:	loose		
Protection degree:	IP68		
Dimension:	Ø 89 x 23 mm		
Weight:	25 g (without battery)		

* Multiple frequency bands of B1 / B3 / B5 / B8 / B20 / B28
 ** Depending on network coverage

Function

When the scanning contact is connected, the detector sends the data message and starts the set alarm.
 The signalling type can be set by the DIP switch.

- The flood detector is used to detect water leakage - the activation occurs the moment the flooding of the contacts located on the underside of the detector occurs.
- Provides a quick solution to learn about unwanted flooding in your bathroom or kitchen that you can react too immediately.
- With a wireless Sigfox / LoRa / NB-IoT communication network the device can be immediately put in the desired location and run immediately.
- Anti-sabotage function - the detector contains a motion sensor and sends a message to the server during any unauthorized manipulation.
- Flood detection is signalled by vibration, optical and acoustic signalling. In the case of water detection, data is sent to the server, ...
- Data is sent to the server from which it can be subsequently displayed as a smartphone, application, or Cloud notification.
- Anti-sabotage: If access to the device is unauthorized, a message is immediately sent to the server.
- Power supply: 1x CR123A battery life approx. 2 years (depending on frequency of use).

Device description

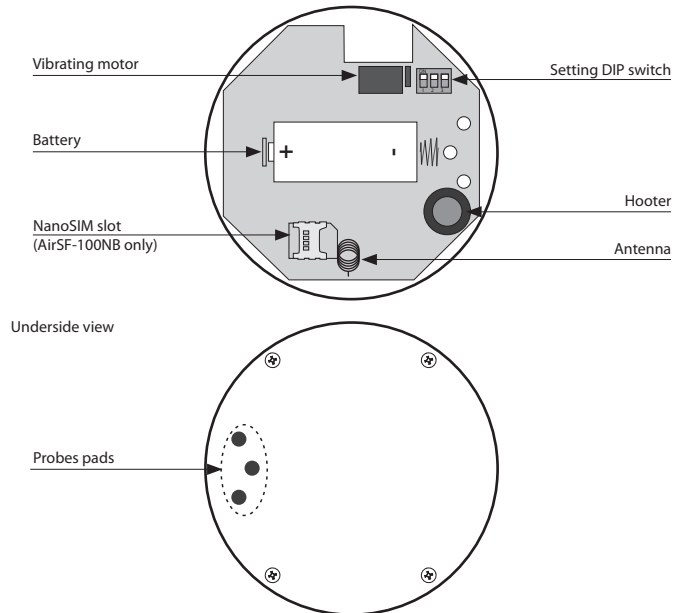

Conductivity of liquids

Liquids suitable for detection		Inadmissible liquids
Type of liquid	Resistivity [Ωcm]*	
Drinking water	5-10 kΩ	Demineralised water
Well water	2-5 kΩ	Deionised water
River water	2-15 kΩ	Bourbon
Rain water	15-25 kΩ	Gasoline
Waste water	0.5-2 kΩ	Oil
Seawater	~0.03 kΩ	Liquid gases
Salt water	~2.2 kΩ	Paraffin
Natural / hard water	~5 kΩ	Ethylene glycol
Chlorinated water	~5 kΩ	Paints
Condensed water	~18 kΩ	High alcohol-content liquids
Milk	~1 kΩ	
Milk serum	~1 kΩ	
Fruit juices	~1 kΩ	
Vegetable Juices	~1 kΩ	
Broths	~1 kΩ	
Wine	~2.2 kΩ	
Beer	~2.2 kΩ	
Coffee	~2.2 kΩ	
Soap foam	~18 kΩ	

* Resistivity characterizes the local conductivity or resistive properties of materials which conduct electric current.

AirWD-100 | Magnetic detector (indoor)



- The magnetic detector is used to detect motion – it is activated by attaching / removing the magnet from the sensor.
- The Sigfox, LoRa or NB-IoT network can be used for message transmission.
- Anti-sabotage function (tamper): When unauthorized interference with the detector occurs (disassembly) it sends an information message to the server.
- Data is sent to the server from which it can be subsequently displayed as a smartphone, application, or Cloud notification.
- Battery status information is sent as a message to the server.
- Power supply: 1x CR123A battery life approx. 2 years (depending on frequency of use).

Technical parameters	AirWD-100S	AirWD-100L	AirWD-100NB
Power supply			
Battery power:	1x CR123A battery		
Battery life:	approx. 2 years (depending on frequency of use)		
Setting			
Alarm Detection:	message to the server		
Battery status view:	message to the server		
Detection			
Closed:	< 1.5 cm		
Open:	> 2 cm		
Reliability:	99.9 %		
Indication			
- red LED:	broadcast		
Sensor:	magnetic / tongue relay		
Communication			
Protocol:	Sigfox	LoRa	NB-IoT
Transmitter frequency:	RCZ1 868 MHz	868 MHz	LTE Cat NB*
Range in open space:	Approx. 50 km**	Approx. 10 km**	Approx. 30 km**
Transmission power (max.):	25 mW / 14 dBm	25 mW / 14 dBm	200 mW / 23 dBm
Other parameters			
Working temperature:	0...+50°C (Pay attention to the operating temperature of batteries)		
Storage temperature:	-30...+70°C		
Operation position:	vertical		
Mounting:	glue / screws		
Protection degree:	IP40		
Color:	white		
Detector			
Dimension / Weight:	31.5 x 75 x 30 mm / 23 g (without battery)		
Magnet D/WD***			
Dimension / Weight:	15 x 75 x 13 mm / 13 g		

* Multiple frequency bands of B1 / B3 / B5 / B8 / B20 / B28

** Depending on network coverage

*** Included in the package

Device description

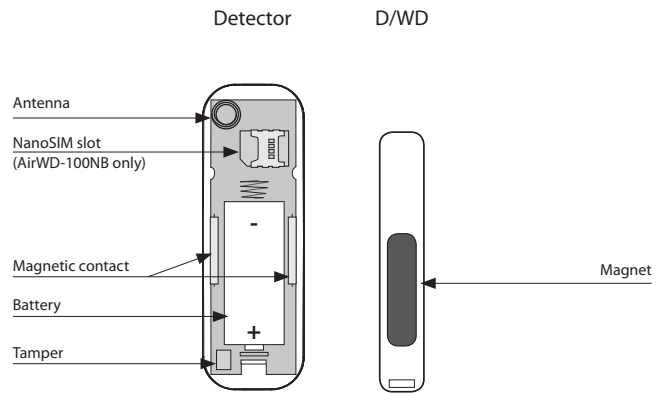

Function

Activation occurs when the magnet is attaching / removed from the sensor. The detector sends a data message every 12 hours. In case of a state change, it sends the data message immediately.

AirWD-101 | Magnetic detector (outdoor)

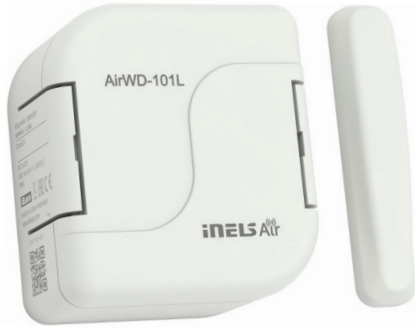

- The magnetic detector is used to detect motion – it is activated by attaching / removing the magnet from the sensor.
- The Sigfox, LoRa or NB-IoT network can be used for message transmission.
- Data is sent to the server from which it can be subsequently displayed as a smartphone, application, or Cloud notification.
- Battery status information is sent as a message to the server.
- Anti-sabotage (tamper): If the device is tampered with, the message is immediately sent to the server.
- Power supply: 1x 3.6 V batteries SAFT with approx. 5 years (depending on the frequency of use).
- Protection degree IP65.

Technical parameters	AirWD-101S	AirWD-101L	AirWD-101NB
Power supply			
Battery power:	1x 3.6V LS 14500 Li-SOCl ₂ AA		
Battery life:	max. 5 years (Depending on the type of sensing and pulse frequency and transmission)		max. 3 years
Standby consumption:	0.2 mW		
Transmitting power consumption:	250 mW	150 mW	850 mW
Setting			
Setting:	Using a message from the server, the programming cable		
Alarm Detection:	message to the server		
Battery status view:	message to the server		
Control			
Control:	Button SET Magnetic contact Tamper		
Detection			
Closed:	< 1.5 cm		
Open:	> 2 cm		
Reliability:	99.9 %		
Sensor:	Reed magnetic contact		
Communication			
Protocol:	Sigfox	LoRa	NB-IoT
Transmitter frequency:	RCZ1 868 MHz	868 MHz	LTE Cat NB1*
Range in open space:	Approx 50 km**	Approx 10 km**	Approx 30 km**
Transmission power (max.):	25 mW / 14 dBm	25 mW / 14 dBm	200 mW / 23 dBm
Other parameters			
Working temperature:	-30... +60 °C (Pay attention to the operating temperature of batteries)***		
Storage temperature:	-30 .. +70°C		
Operation position:	vertical		
Mounting:	glue / screws		
Protection degree:	IP65		
Detector			
Dimension / Weight:	70 x 62 x 34 mm / 43 g (without battery)		
Magnet D/WD****			
Dimension / Weight:	15 x 75 x 13 mm / 13 g		

* Multiple frequency bands of B1 / B3 / B5 / B8 / B20 / B28
 ** Depending on network coverage
 *** Pay attention to the operating temperature of batteries -60...+85 °C
 **** Included in the package

Device description

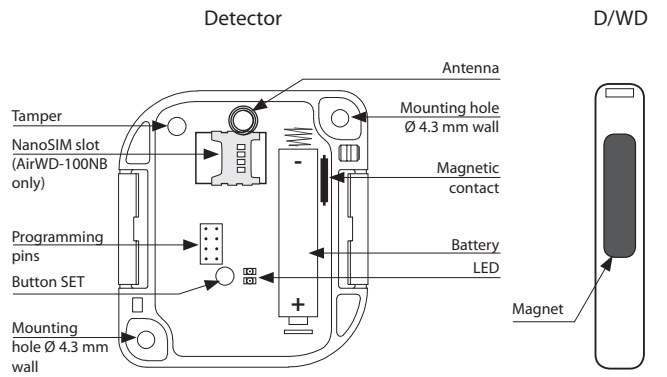

Function

Activation occurs when the magnet is attaching / removed from the sensor. The detector sends a data message every 12 hours. In case of a state change, it sends the data message immediately.

AirSD-100 | Smoke detector



Technical parameters	AirSD-100S	AirSD-100L	AirSD-100NB
Power supply			
Battery power:	battery 4x 1.5 V AA		
Battery life:	approx. 1 year		
Input			
Smoke Detection:	built-in sensor		
Detection:	smoke from burning		
Detection principle:	optical-smoke scanning technology		
Response Time:	a few seconds after contact with the smoke		
Temperature measuring:	built-in sensor		
Range:	-25 .. 70 °C		
Accuracy:	± 3 °C		
Humidity measuring:	built-in sensor		
Sensitivity:	0 .. 90 % RH		
Accuracy:	± 4 %		
Light intensity measurement:	built-in sensor		
Range:	0.045 - 188 000 Lx		
Setting			
Alarm Detection:	message to the server, indication LED, audible alarm		
Battery status view:	message to the server, indication LED		
Button SET:	Test / setting / signalling		
DIP switch:	Position 1 - Turn off scanning signaling		
Control			
Detection area:	max. 40 m ³		
Recommended installation height:	max. 4 m		
Acoustic signal:	greater than 85 dB at 3 meters		
Test button SET:	yes		
Communication			
Protocol:	Sigfox	LoRa	NB-IoT
Transmitter frequency:	RCZ1 868 MHz	868 MHz	LTE Cat NB1*
Range in open space:	Approx. 50 km**	Approx. 10 km**	Approx. 30 km**
Transmission power (max.):	25 mW / 14 dBm	25 mW / 14 dBm	200 mW / 23 dBm
Other parameters			
Humidity:	up to 92% relative humidity (RH) / 10% to 85% RH, no condensation or frost		
Working temperature:	0...+40°C (Pay attention to the operating temperature of batteries)		
Storage temperature:	-30...+70°C		
Operation position:	Horizontal (ceiling) / Vertical (Wall)		
Mounting:	screws		
Protection degree:	IP20		
Color:	white		
Dimension:	Ø 120 x 36 mm		
Weight:	176 g (without battery)		

- The smoke detector is used for the early warning of an emerging fire in residential and commercial buildings and also measures the actual temperature, humidity and light intensity in the room.
- The detector utilises a scanning method using an optical chamber, which has enhanced smoke detection responses.
- Self-test function highlights the failure of the detector, eliminating the malfunction in the event of a fire.
- Anti-sabotage: If access to the device is unauthorized, a message is immediately sent to the server.
- Thanks to the wireless solution and Sigfox / LoRa / NB-IoT communication, it can communicate instantly to your chosen location and be operated immediately.
- Data is sent to the server from which it can be subsequently displayed as a smartphone, application, or Cloud notification.
- Battery power can be sent to the server when it is powered by a battery.
- Power supply: battery 4 x 1.5 V AA, the battery life is around 1 year.

Device description

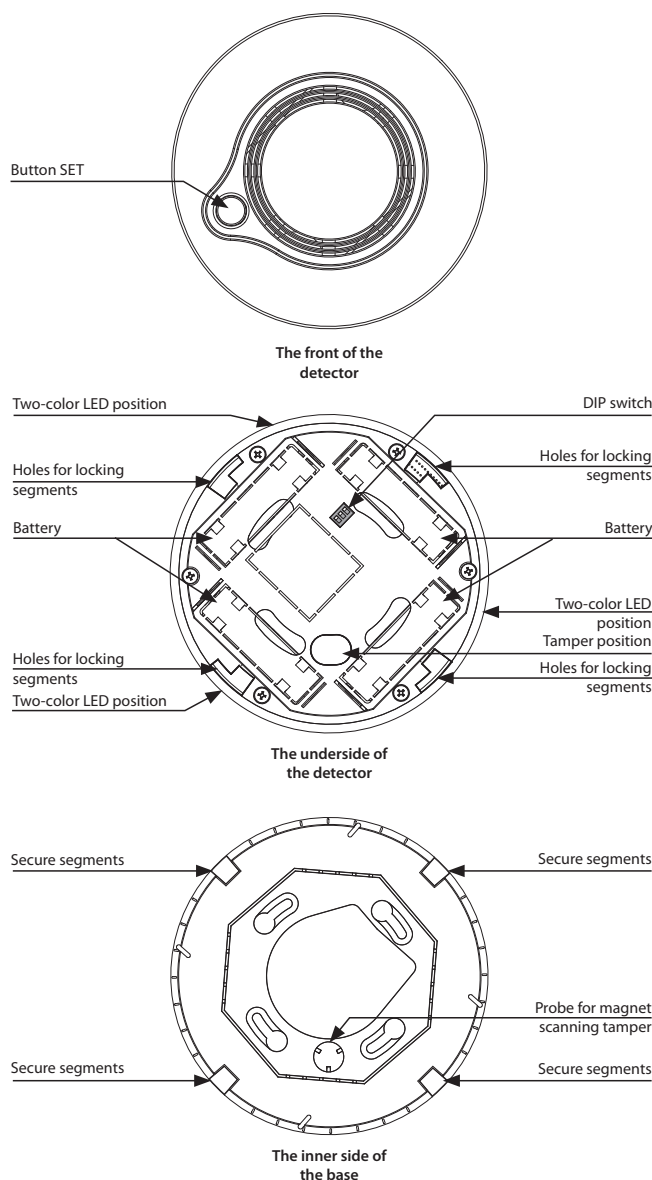

* Multiple frequency bands of B1 / B3 / B5 / B8 / B20 / B28

** Depending on network coverage

Function

An internal, battery-powered smoke detector combines the timely detection of smouldering and open fires from which smoke escapes. It is equipped with an optical smoke detector for smoke detection. An example of a smouldering fire is a burning cigarette on a couch or bedding, which is a common cause of fires.

Indicators and detector states

After inserting the batteries, the detector sends an introductory message containing the measured temperature, humidity, light intensity, optical-smoke sensor status, and firmware version of the device.

- The detector scans for smoke every 10 seconds, the green LED blinks at the same time (the LED signalling can be switched off by the DIP switch). Every 10 minutes the detector senses temperature, humidity and light intensity. Displays the measured data report at six hourly intervals. In the case of smoke detection or rapid temperature change it is displayed immediately.
- Alarm - the sensor detects smoke, the red LED blinks within 1 second, the detector emits a loud, intermittent „beep“. Terminate the alarm by scattering the smoke. The audible alarm can be switched off by the test button, in the case of positive smoke detection; the audible alarm is restored after 5 minutes.
- Dead battery:
 - sending a message to the server
 - every 5 s 3 times the red LED lights up on the detector.
- Detector failure:
 - sending a message to the server
 - Indication of the red LED on the detector and one short beep every 40 seconds.
- Removed from base:
 - sending a message to the server
 - every 3 seconds the red LED lights up on the detector.

Location

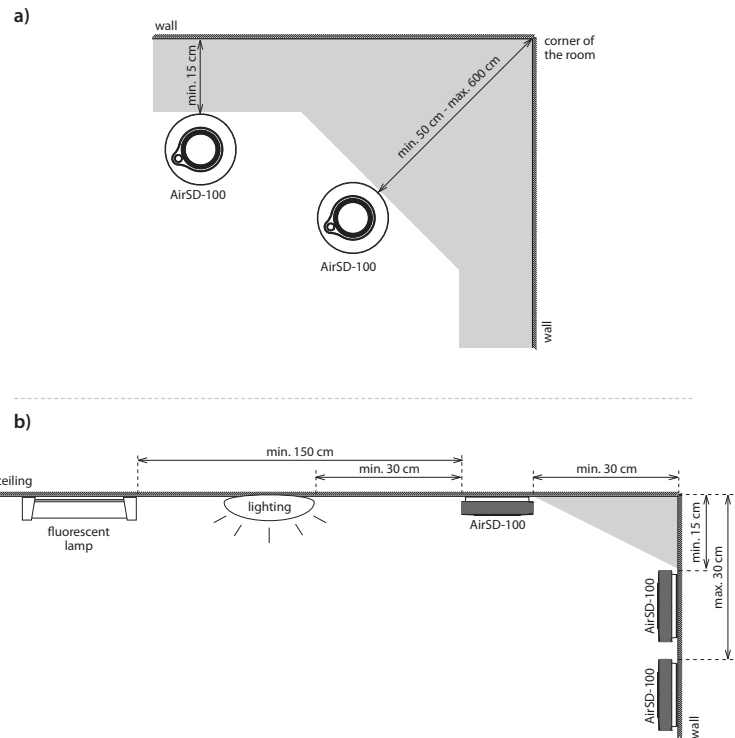

Appropriate location

In new buildings, install smoke detectors according to the project.

- Smoke and other combustion products rise to the ceiling and expand horizontally. In residential buildings we recommend installing smoke detectors in the middle of the ceiling.
- Detector area is 40 m³. Make sure that the smoke detector is located at least 15 cm from the side wall and 50 cm from each corner of the room (fig. A). Max. The recommended installation height is 4 m.
- In the rooms with a sloping, pointed or saddle roof (e.g. attics) the smoke detectors are mounted on the ceiling at a distance of 90 cm from the highest point.
- When installing on a wall, place the detector 15 -30 cm below the ceiling (Figure b). The bottom of the detector should be located above the top edge of all doors, windows and other openings.
- Although it is most appropriate to install a fire detector, it is recommended to place it in a connection room such as a staircase or hallway. The triggering of the alarm is delayed, but it will limit the number of the false alarms from the smoke of burnt pans or smoke from the fireplace.
- To increase security, detectors should be installed in each room of the building.

AirQS-100 | Air quality sensor - carbon dioxide (CO₂)



- AirQS-100 - monitors the CO₂ content of the room and also measures the actual temperature, humidity and light intensity in the room.
- Anti-sabotage: If access to the device is unauthorized, a message is immediately sent to the server.
- Thanks to the wireless solution and Sigfox / LoRa / NB-IoT communication, it can communicate instantly to your chosen location and be operated immediately.
- Data is sent to the server from which it can be subsequently displayed as a smartphone, application, or Cloud notification.
- Power supply 110-240 V AC.

Technical parameters	AirQS-100S	AirQS-100L	AirQS-100NB
Power supply			
External power supply:	110 - 240 V AC		
Input			
Measurement of CO ₂ concentration:	YES		
Sensitivity:	300 - 5 000 ppm		
Accuracy:	5% (0 - 180 ppm)		
Temperature measuring:	built-in sensor		
Sensitivity:	-25 .. 70 °C		
Accuracy:	± 3 °C		
Humidity measuring:	built-in sensor		
Sensitivity:	0 .. 90 % RH		
Accuracy:	± 4 %		
Light intensity measurement:	built-in sensor		
Range:	0.045 - 188 000 Lx		
Setting			
Alarm Detection:	message to the server		
Indication			
Red / green LED:	See manual		
Detection area:	max. 40 m ³		
Recommended installation height:	max. 4 m		
Communication			
Protocol:	Sigfox	LoRa	NB-IoT
Transmitter frequency:	RCZ1 868 MHz	868 MHz	LTE Cat NB1*
Range in open space:	Approx. 50 km**	Approx. 10 km**	Approx. 30 km**
Transmission power (max.):	25 mW / 14 dBm	25 mW / 14 dBm	200 mW / 23 dBm
Other parameters			
Working temperature:	0...+40 °C		
Storage temperature:	-30...+70 °C		
Operation position:	Horizontal (ceiling) / Vertical (Wall)		
Mounting:	screws		
Protection degree:	IP20		
Color:	white		
Dimension:	Ø 120 x 36 mm		
Weight:	185 g		

* Multiple frequency bands of B1 / B3 / B5 / B8 / B20 / B28

** Depending on network coverage

Device description

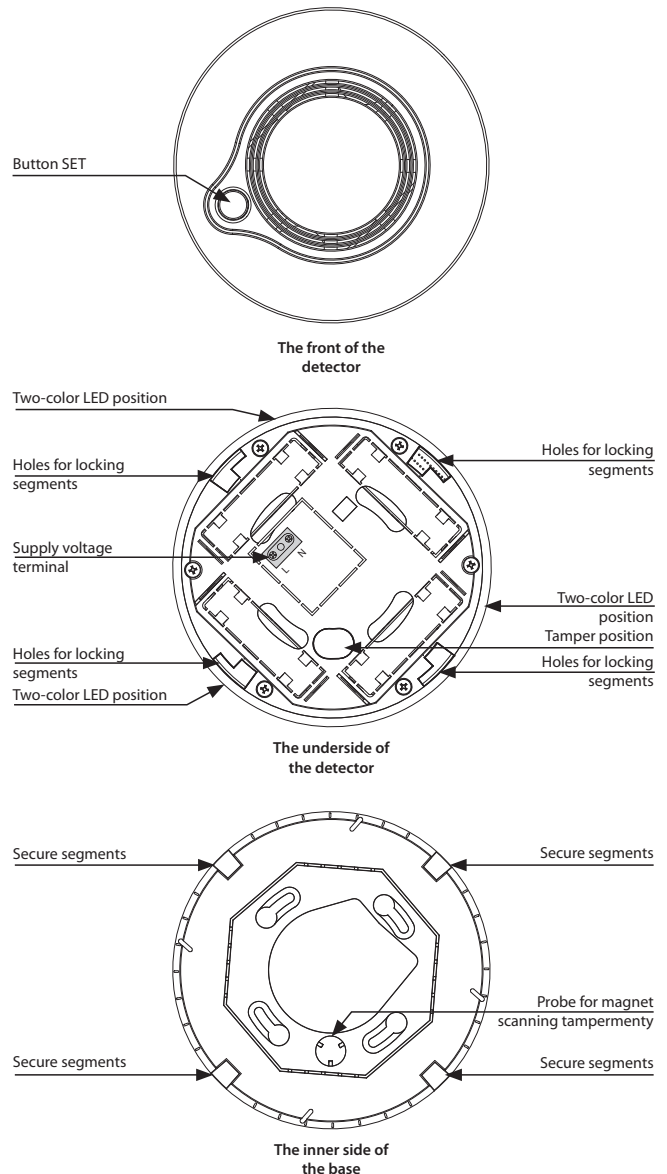

Function

The detector detects the carbon dioxide (CO₂) content in confined spaces by means of a sensor. Sending a message to the server alerts you to the need air the space

Indications and states of the detector

After the power supply is connected, the detector sends an introductory message containing the measured values of temperature, light intensity, humidity, CO₂ level and firmware version of the device.

- Sends a data message about the measured values and the status of the detector every 10 minutes.
- Indication of measured CO₂ concentration
 - the green LED blinks briefly - the measured values are OK.
 - Red LED blinks briefly - CO₂ concentration is higher than 1500 ppm. Air quality is undesirable. It is necessary to air the room.
- Supply voltage indication
 - The green LED is lit under the button.
- Removed from base:
 - sending a message to the server.
 - every 2 seconds the red LED on the detector blinks.

Location

Appropriate location

- Carbon dioxide is heavier than air. The best location for determining the average CO₂ concentration is about 1.6 m above the floor.
- The detector should be placed in the bedrooms and rooms where you regularly spend time (offices, classrooms ...).

AirQS-101 | Air quality sensor - carbon monoxide (CO)



Technical parameters	AirQS-101S	AirQS-101L	AirQS-101NB
Power supply			
Battery power:	battery 4x 1.5 V AA*		
Battery life:	approx. 1 year		
Input			
Measurement of CO concentration:	YES		
Sensitivity:	0 - 10 000 ppm		
Accuracy:	5% (0 - 500 ppm)		
Temperature measuring:	built-in sensor		
Sensitivity:	-25 .. 110 °C		
Accuracy:	± 3 °C		
Humidity measuring:	built-in sensor		
Sensitivity:	0 .. 90 % RH		
Accuracy:	± 4 %		
Light intensity measurement:	built-in sensor		
Range:	0.045 - 188 000 Lx		
Setting			
Alarm Detection:	message to the server, indication LED, audible alarm		
Battery status view:	message to the server, indication LED		
Button SET:	Test / setting / signalling		
DIP switch:	Position 1 - Turn off scanning signaling		
Control			
Detection area:	max. 40 m ³		
Recommended installation height:	max. 4 m		
Acoustic signal:	greater than 85 dB at 3 meters		
Test button SET:	yes		
Communication			
Protocol:	Sigfox	LoRa	NB-IoT
Transmitter frequency:	RCZ1 868 MHz	868 MHz	LTE Cat NB1*
Range in open space:	Approx. 50 km**	Approx. 10 km**	Approx. 30 km**
Transmission power (max.):	25 mW / 14 dBm	25 mW / 14 dBm	200 mW / 23 dBm
Other parameters			
Humidity:	up to 92% relative humidity (RH) / 10% to 85% RH, no condensation or frost		
Working temperature:	0...+40°C (Pay attention to the operating temperature of batteries)		
Storage temperature:	-30...+70°C		
Operation position:	Horizontal (ceiling) / Vertical (Wall)		
Mounting:	screws		
Protection degree:	IP20		
Color:	white		
Dimension:	Ø 120 x 36 mm		
Weight:	184 g (without battery)		

- AirQS-101 - is used as a safety device for monitoring the CO concentration resulting from incomplete combustion. It also informs you of the actual temperature, humidity and light intensity in the area.
- Provides a quick solution to learn about undesirable CO concentrations that can be immediately reacted too.
- The self-test function alerts you to a detector malfunction, eliminating its malfunction.
- Anti-sabotage: If access to the device is unauthorized, a message is immediately sent to the server.
- Thanks to the wireless solution and Sigfox / LoRa / NB-IoT communication, it can communicate instantly to your chosen location and be operated immediately.
- Data is sent to the server from which it can be subsequently displayed as a smartphone, application, or Cloud notification.
- Battery power can be sent to the server when it is powered by a battery.
- Power supply: battery 4 x 1.5 V AA, the battery life is around 1 year.

Device description

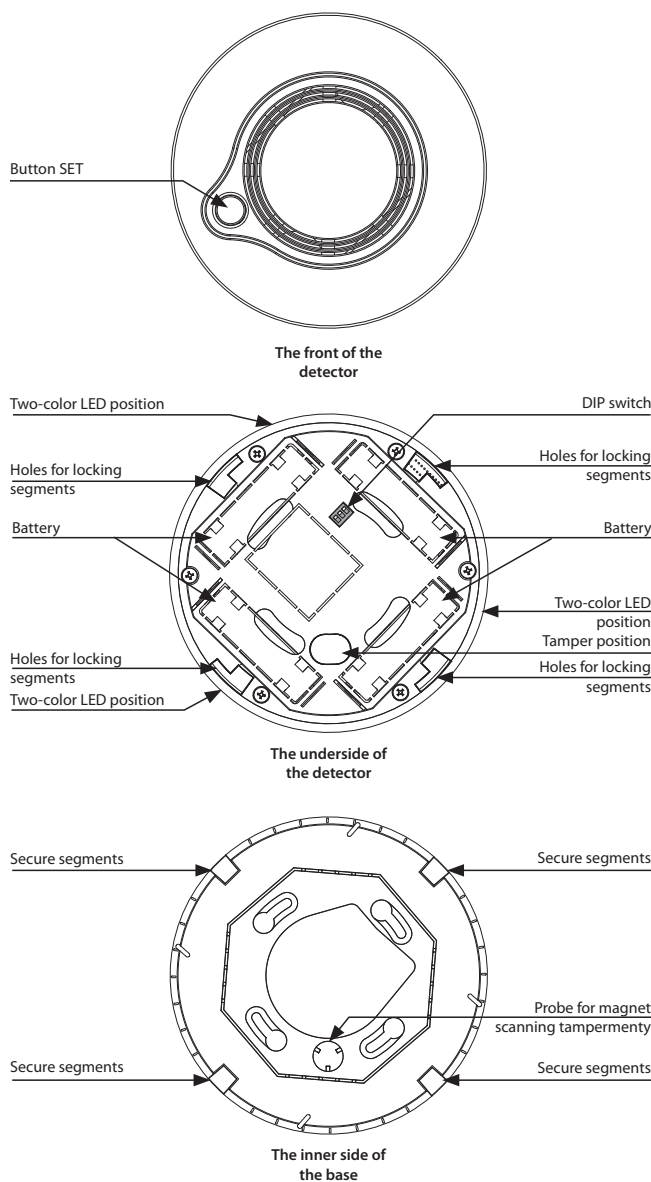

* Multiple frequency bands of B1 / B3 / B5 / B8 / B20 / B28

** Depending on network coverage

Function

The detector detects carbon monoxide (CO) content in confined spaces by means of a sensor. It is designed to alert you to the presence of CO before the condition becomes critical - that is, before most people experience the symptoms of CO poisoning, so you have time to solve the problem calmly.

Indications and states of the detector:

After inserting the batteries, the detector sends a preliminary message containing the measured values of temperature, humidity, light intensity, CO status and firmware version of the device.

- The detector scans every 10 seconds, the green LED blinks at the same time (the LED can be turned off by a DIP switch). Every 10 minutes the detector senses temperature, humidity and light intensity. It sends the measured and status data report at six hour intervals.
- Alarm indication for CO detection:
 - 30 ppm = no alarm signalled within 120 minutes.
 - 50 ppm = alarm signalling within 60-90 minutes.
 - 100 ppm = Alarm signalling within 10-40 minutes.
 - Above 300 ppm, the detector must declare an alarm within 3 minutes.
- Alarm - sensor detects CO, red LED flashes at 1 second, detector sounds loud, intermittent "beep". Terminate alarm by ventilating the CO (fan ...).
- Dead battery:
 - sending a message to the server
 - Every 5 seconds 3x the red LED on the detector will flash.
- Detector failure:
 - sending a message to the server
 - Indication of the red LED on the detector and one short beep every 40 seconds.
- Removed from base:
 - sending a message to the server.
 - every 2 seconds the red LED on the detector blinks.

Location

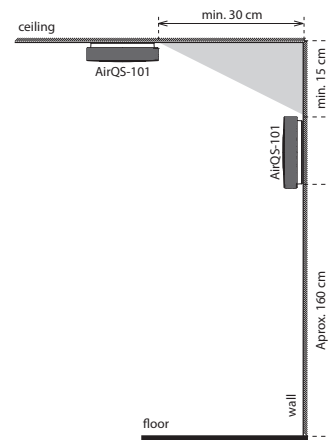

Appropriate location

- Carbon monoxide has the same density as the air in the room and is therefore uniformly dispersed. However, since CO originates as a product of an incomplete combustion process, it is very likely that it will have a higher temperature than the ambient air and will therefore slowly climb to the ceiling. Detector location is useful at a height of about 1.6 m above the floor.
- If you attach the device to a wall, it must be higher than the top edge of the window and door but at least 15 cm below the ceiling.
- If you attach the device to the ceiling, it must be at least 30 cm from each wall
- If the ceiling is inclined, place the device in the upper part of the room
- To increase security, detectors should be installed in any room with a fuel-burning appliance (gas, wood, coal, etc.) 2-3 meters away from the CO source (boiler, fireplace, water heater ...).
- Warning sound of the detector must be heard in the bedroom and rooms where you regularly spend time.
- In one-room sleeping and living rooms at the same time, such as studios, caravans or boats, the detector should be placed as near as possible to the sleeping area and as far as possible from the stove or combustion point.
- It is recommended that the CO detector be installed on each floor of a multi-storey house (e.g. CO in the cellar may not reach the alarm on the 1st floor).

AirSLC-100/LWES | Street light controller - LUMAWISE plug



- Used for remote control of the luminaire: ON / OFF / DIMM.
- It informs about the fault of the ballast, light source, connecting wires ...
- Communicates over the wireless LPWAN network (LoRa or NB-IoT).
- Output signal 0 (1) -10V or DALI for direct control of ballast in luminaire.
- Internal digital light intensity sensor, range 5 - 100,000Lx.
- Internal digital temperature sensor in the range -30 ... 70 ° C.
- Supply voltage: 12- 24 V DC.
- Protection IP65, UV resistant, designed for outdoor installation in the LUMAWISE ENDURANCE S.
- Update using the RFAF / USB Service Key.

Technical parameters	AirSLC-100L/ LWES/DALI	AirSLC-100NB/ LWES/DALI	AirSLC-100L/ LWES/0-10	AirSLC-100NB/ LWES/0-10
Supply voltage:	12 - 24 V DC			
Supply voltage tolerance:	-10 /+15 %			
Standby consumption:	0.5 W			
Consumption max.:	at 1.5 W communication			
Temperature sensor				
Range:	-30 .. 70°C			
Accuracy:	±1°C in the range -10°C .. 70°C ±3°C in the range -30°C .. -10°C			
Light sensor				
Scanned Range:	5 - 100 000 Lx			
Detection angle:	130°			
Indication				
- blue LED:	module power supply			
- green LED:	STATUS module			
- red LED:	LPWAN communications			
Inputs				
Communication Interface:	DALI polarized - active (20mA)		Analog 0(1)-10 V (20mA)	
External relay:	x		12 / 24 V DC, max. 250 mA	
Communication				
Protocol:	LoRa	NB-IoT*	LoRa	NB-IoT*
Transmitter frequency:	868 MHz	LTE Cat NB1**	868 MHz	LTE Cat NB1**
Range in open space:	Approx. 10 km ***	Approx. 30 km***	Approx. 10 km***	Approx. 30 km***
Transmission power (max.):	25 mW / 14 dBm	200 mW / 23 dBm	25 mW / 14 dBm	200 mW / 23 dBm
Protocol:	iNELS RF Control			
Transmitter frequency:	866 MHz, 868 MHz, 916 MHz			
Range in open space:	up to 20 m			
Other parameters				
Working temperature:	-30 .. +70 °C			
Storage temperature:	-30 .. +70 °C			
Operation position:	See manual			
Mounting:	in socket			
Protection degree:	IP65			
Overvoltage category:	III.			
Pollution degree:	2			
Dimension:	Ø 80 x 40 mm			
Weight:	64 g			

Device description

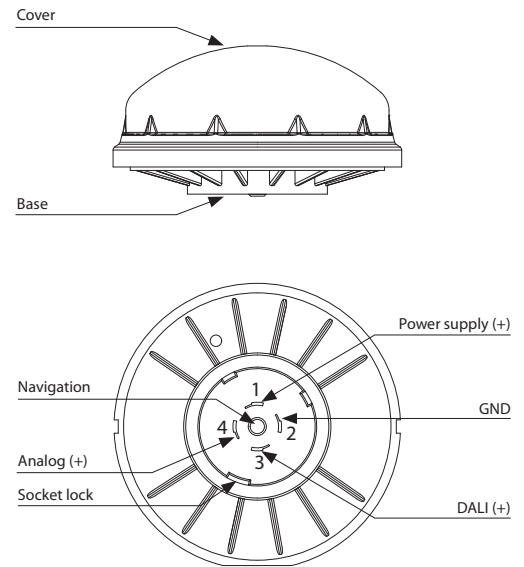

Disintegration

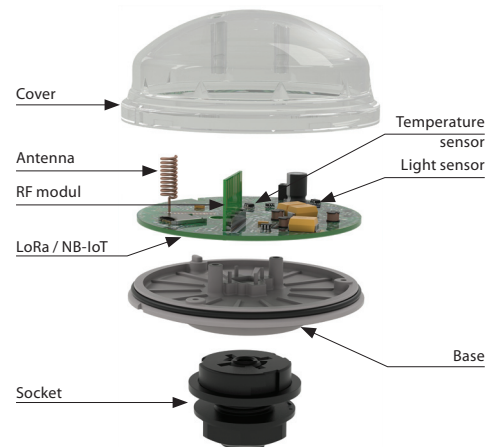

* nanoSIM / eSIM

** Multiple frequency bands of B1 / B3 / B5 / B8 / B20 / B28

*** Depending on network coverage

Function

- When the power is connected, the device sends the initial message containing the measured temperature and light intensity.
- Mode setting (message from server):
- Manual:
 - turn on / off, adjust brightness
 - scanning and data transmission interval of temperature and light intensity data (range)
- Automatic:
 - the on / off is controlled according to the intensity measured by the light sensor
 - sensor senses temperature and intensity of lighting every 2 minutes. After that, it sends a data message of measured values every 60 minutes.

Example connection

Connection 0 (1) -10V (analog) + tripping relay

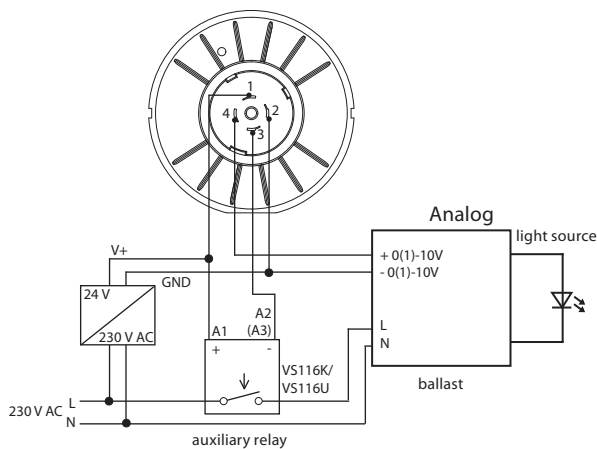

Connection 0 (1) -10V (analog) without relay

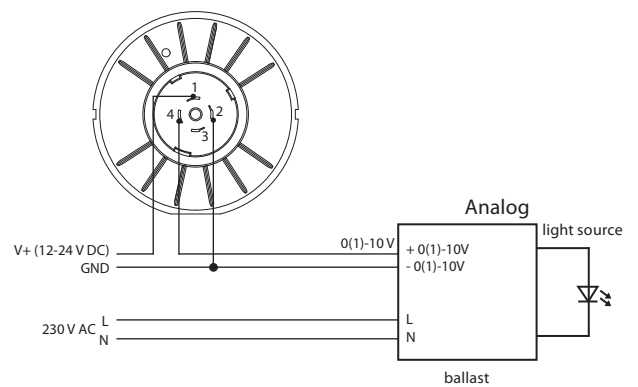

In the off state, the analog ballast may light up slightly (depending on gear type).

Description of wiring contacts:

- 1 - 12/24 V power supply
- 2 - GND / analog output 0(1) - 10 V (-)
- 3 - control of an external relay
- 4 - analog output 0(1)-10 V (+)

Connection DALI

Connection of one DALI light

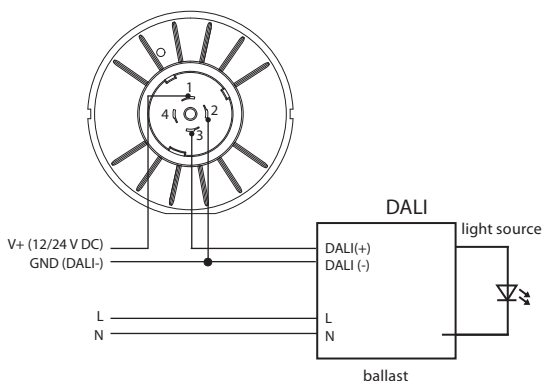

Description of wiring contacts:

- 1 - 12/24 V power supply
- 2 - GND / DALI(-)
- 3 - DALI(+)

For the management of DALI BUS there is not an exact cable type recommended, but it is important to keep some installation conditions.

For DALI BUS lines up to 100 m the recommended min. conductor cross section is 0.5 mm². For management between 100 m -150 m a cross section of 0.75 mm² and more than 150 m the recommended min is 1.5 mm². Management of more than 300 m is not recommended. The voltage drop at the end of the installation may not be greater than 2 V.

AirSLC-100/NEMA | Street light controller - NEMA socket



- Used for remote control of the luminaire: ON / OFF / DIMM.
- Measures current flow - fault detection (ballast fault, light source, connecting wires ...)
- Communicates over the wireless LPWAN network (LoRa or NB-IoT).
- Output signal 0 (1) -10V or DALI for direct control of ballast in luminaire.
- Internal digital light intensity sensor, range 5 - 100,000Lx.
- Internal digital temperature sensor in the range -30 ... 70 °C.
- Power supply: 100-230 V AC, Power 3.5 VA.
- The IP66, UV-resistant, is designed for outdoor mounting in the NEMA socket.
- Update using the RFAF / USB Service Key.
- Connection standard: Standard ANSI C136.41 Dimming Receptacle.

Technical parameters	AirSLC-100L/ NEMA/DALI	AirSLC-100NB/ NEMA/DALI	AirSLC-100L/ NEMA/0-10	AirSLC-100NB/ NEMA/0-10
Supply voltage::	AC 100 - 230 V AC			
Power:	3.5 VA			
Supply voltage tolerance:	-10 /+15 %			
Standby consumption:	0.5 W			
Consumption max.:	at 2 W communication			
Temperature sensor				
Range:	-30 .. 70°C			
Accuracy:	±1°C in the range -10°C .. 70°C ±3°C in the range -30°C .. -10°C			
Light sensor				
Scanned Range:	5 - 100 000 Lx			
Detection angle:	130°			
Indication				
- blue LED:	module power supply			
- green LED:	STATUS module			
- red LED:	LPWAN communications			
Inputs				
Communication Interface:	DALI polarized - active (20 mA)		Analog 0(1)-10 V (20mA)	
Power outputs L, N, V	Load max. 15 A			
Communication				
Protocol:	LoRa	NB-IoT*	LoRa	NB-IoT*
Transmitter frequency:	868 MHz	LTE Cat NB1**	868 MHz	LTE Cat NB1**
Range in open space:	Approx. 10 km***	Approx. 30 km***	Approx. 10 km***	Approx. 30 km***
Transmission power (max.):	25 mW / 14 dBm	200 mW / 23 dBm	25 mW / 14 dBm	200 mW / 23 dBm
Protocol:	iNELS RF Control			
Transmitter frequency:	866 MHz, 868 MHz, 916 MHz			
Range in open space:	up to 20 m			
Other parameters				
Working temperature:	-30 .. +50 °C			
Storage temperature:	-30 .. +70 °C			
Operation position:	See manual			
Mounting:	in socket			
Protection degree:	IP66			
Overvoltage category:	III.			
Pollution degree:	2			
Dimension:	Ø 88 x 96 mm			
Weight:	160 g			

* nanoSIM / eSIM

** Multiple frequency bands of B1 / B3 / B5 / B8 / B20 / B28

*** Depending on network coverage

For the management of DALI BUS there is not an exact cable type recommended, but it is important to keep some installation conditions.

For DALI BUS lines up to 100 m the recommended min. conductor cross section is 0.5 mm². For management between 100 m -150 m a cross section of 0.75 mm² and more than 150 m the recommended min is 1.5 mm². Management of more than 300 m is not recommended. The voltage drop at the end of the installation may not be greater than 2 V.

Example connection

Connection 0 (1) -10V (analog)

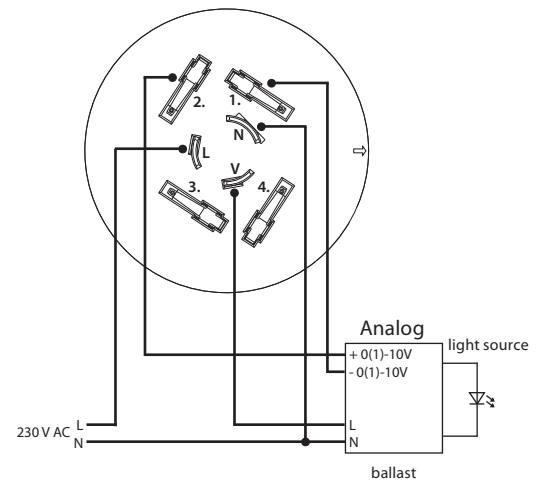

Description of wiring contacts:

1. 0(1) - 10 V (-)
 2. 0(1)-10 V (+)
 3. not connected
 4. not connected
- L (LINE)- phase
N (NEUT) - neutral
V (LOAD) - switched output

Connection DALI

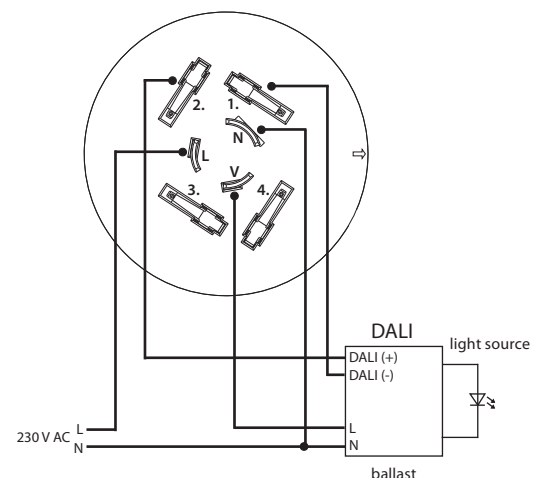

Description of wiring contacts:

1. DALI -
 2. DALI +
 3. not connected
 4. not connected
- L (LINE)- phase
N (NEUT) - neutral
V (LOAD) - switched output

AirSLC-100/NEMA | Street light controller - NEMA socket

Device description

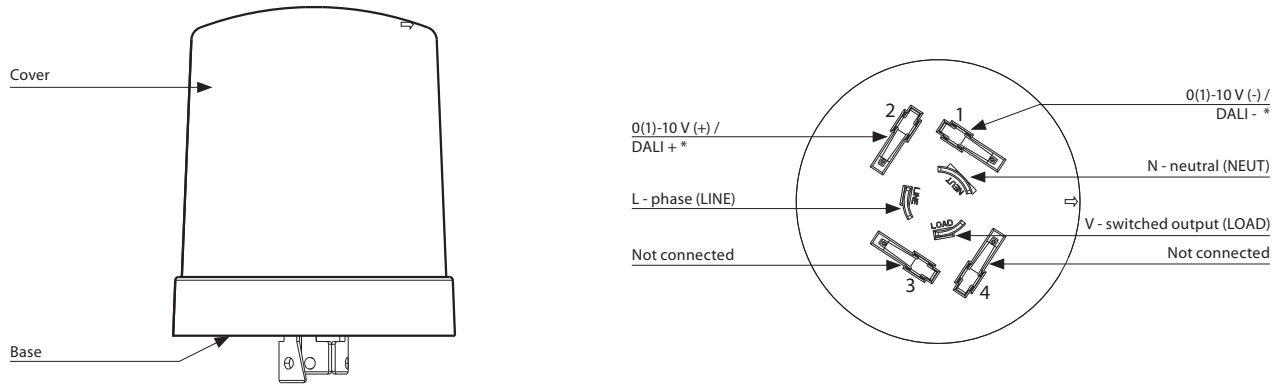

* by module type (analog / DALI)

Function

- When the power is connected, the device sends the initial message containing the measured temperature and light intensity.
- Mode setting (message from server):
- Manual:
 - turn on / off, adjust brightness
 - scanning and data transmission interval of temperature and light intensity data (range)
- Automatic:
 - the on / off is controlled according to the intensity measured by the light sensor
 - sensor senses temperature and intensity of lighting every 2 minutes. After that, it sends a data message of measured values every 60 minutes.

Disintegration

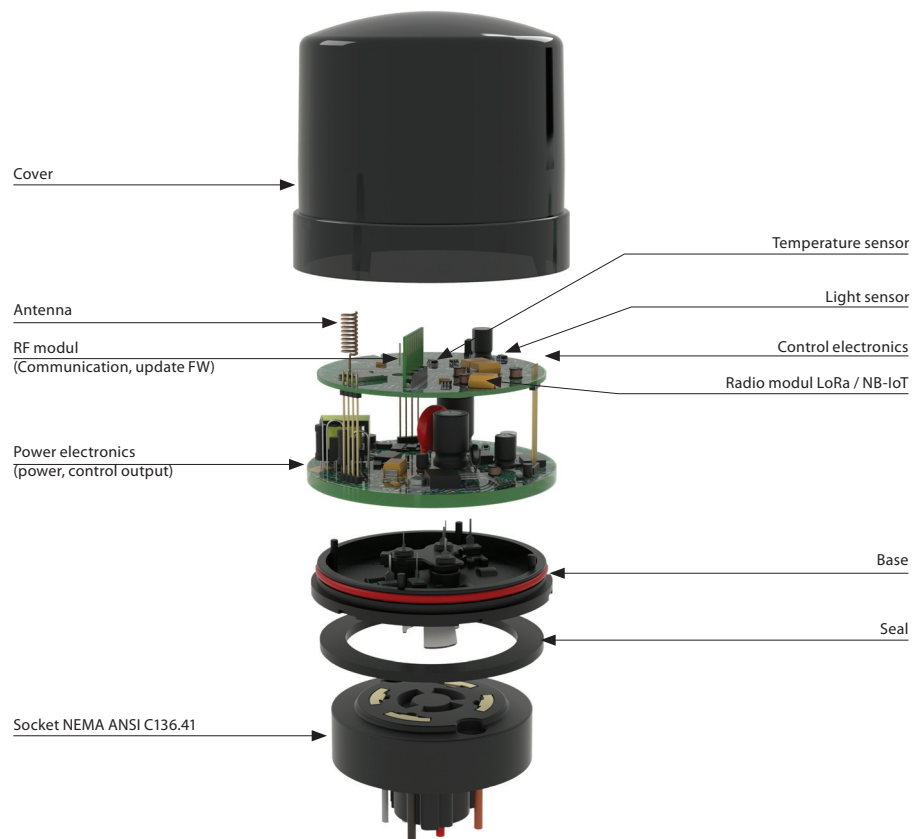

AirSLC-100 | Street light controller (DALI)



- Used for remote control of the luminaire: ON / OFF / DIMM.
- Module measures current flow - fault detection (ballast fault, light source, connecting wires ...).
- The two-directional communication module is intended primarily for monitoring and switching of public lighting in cities,
- Using a monitoring and switching component will help you eliminate financial costs.
- Communicates over the wireless LPWAN network (LoRa).
- Data is sent to the server from which it can be subsequently displayed as a smartphone, application, or Cloud notification.
- Update using the RFAF / USB Service Key.

Technical parameters		AirSLC-100L/DALI
Supply voltage:	110 - 230 V AC / 50 - 60 Hz	
Apparent input:	3 VA	
Dissipated power:	1.2 W	
Supply voltage tolerance:	+10 / -15 %	
Output		
Communication Interface:	active (self-powered) polarized, the ability to connect one device	
Output voltage:	20 mA	
Relay contacts:	1x AgSnO ₂ , switch the phase conductor	
Current rating:	10 A / AC1	
Breaking capacity:	2 500 VA / AC1	
Switching voltage:	250 V AC1	
Mechanical life:	1x10 ⁷	
Electrical life:	1x10 ⁵	
Measurement of consumption		
Type:	current flow	
Range:	± (20 mA ... 10 A)	
Setting		
Setting:	message from the server	
Control		
Control:	With a message from the server / button TEST	
Output Indication Indicator:	green LED	
Indication:	red LED	
Communication		
Protocol:	LoRa	
Transmitter frequency:	868 MHz	
Range in open space:	Approx. 10 km*	
Transmission power (max.):	25 mW / 14 dBm	
Other parameters		
Working temperature:	-15 ... + 50 °C	
Operation position:	any	
Mounting:	glue / screws**	
Protection degree:	IP44	
Overvoltage category:	III.	
Pollution degree:	2	
Cable		
part of the product		
- Cross section:	Ø 8 mm	
- length:	45 cm	
- terminals:	3x 1.5 mm ² , 2x 0.5 mm ²	
Length of individual wires:	5 cm	
Cable grommet:	M16 x 1.5 for cable Ø max. 10 mm	
Dimension:	182 x 62 x 34 mm	
Weight:	162 g	

Device description

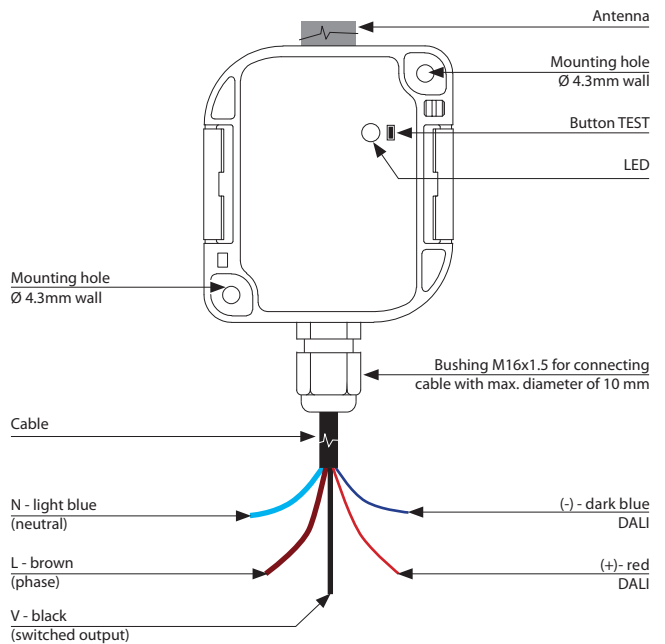

Example connection

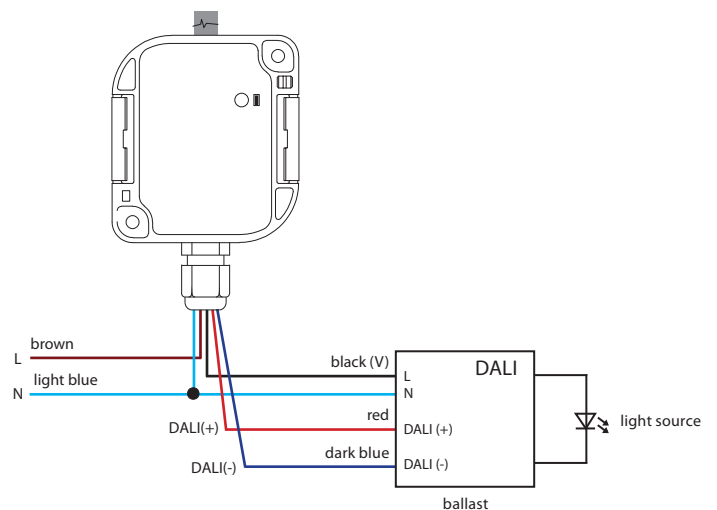

* Depending on network coverage

** Do not enclose in metal switchboards and the like.



Technical parameters	AirSOU-100S	AirSOU-100L	AirSOU-100NB
Photo sensor parameters			
Light measurement range:	1 - 100 000 lx		
Detection angle:	100°		
Power supply			
Battery power:	1x 3.6V LS 14500 Li-SOCl ₂ AA		
Battery life:	max. 5 years		max. 3 years
(Depending on settings)			
External power supply:	5- 12 V DC (on terminal)		
Supply voltage tolerance:	+10 %; -15%		
Standby consumption:	0.2 mW		
Transmitting power consumption:	250 mW	150 mW	850 mW
Setting			
Setting:	Using a message from the server, the programming cable		
Battery status view:	message to the server		
Control			
Control:	button (Communication test) Tamper		
Communication			
Protocol:	Sigfox	LoRa	NB-IoT
Transmitter frequency:	RCZ1 868 MHz	868 MHz	LTE Cat NB1*
Range in open space:	Approx. 50 km**	Approx. 10 km**	Approx. 30 km**
Transmission power (max.):	25 mW / 14 dBm	25 mW / 14 dBm	200 mW / 23 dBm
Other parameters			
Working temperature:	-30...+60°C (Pay attention to the operating temperature of batteries)***		
Storage temperature:	-30...+70°C		
Operation position:	vertical		
Mounting:	glue / screws		
Protection degree:	IP65		
Dimension with antenna:	158 x 62 x 34 mm		
Weight:	108 g (without battery)		

* Depending on network coverage

** Multiple frequency bands of B1 / B3 / B5 / B8 / B20 / B28

*** Pay attention to the operating temperature of batteries -60...+85 °C

- Information about the actual light intensity can be used in the task of maintaining a constant illumination in a given space, where it is possible to regulate the intensity of artificial lighting thanks to the contribution of natural lighting from outside, thereby reducing the energy consumption.
- AirSOU-100 can be used not only in residential projects, but also in commercial office projects or production and warehouse or production halls.
- The AirSOU-100 is recommended to be installed so that the light sensing sensor is facing downwards and not exposed to direct light.
- The scanning range is 1 - 100,000 lux.
- Data is sent to the server from which it can be subsequently displayed as a smartphone, application, or Cloud notification.
- Battery power can be sent to the server when it is powered by a battery.
- The AirSOU-100 is supplied in an IP65 enclosure and can be installed in an outdoor environment.

Device description

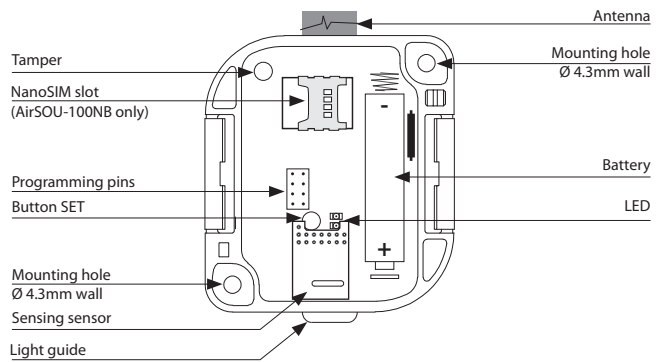

Function

After inserting the batteries, the sensor sends an introductory message containing the measured light intensity.

The sensor scans the light intensity every 2 minutes. After that, it sends a data message of measured values every 60 minutes. In the event of a sudden change in light intensity, it sends the data message immediately.

AirPD-100 | Parking detector



- Parking detectors can be used in corporate parking lots, car parks at department stores or administrative complexes etc.
- Detects free or occupied parking spaces. To determine the current state of the parking space, it uses the anomaly measurements in the magnetic field of the ground, in the immediate vicinity of the detector.
- Detector is resistance to external influences (UV, salt, snow plough).
- With the wireless solution and Sigfox / LoRa / NB-IoT communication, it can communicate instantly to Server and be operated immediately.
- Battery power with a lifetime of about 10 years

Technical parameters	AirPD-100S	AirPD-100L	AirPD-100NB
Power supply			
non-removable battery			
Battery power:	2 x Li-SOCl ₂ 3.6V		
Battery life:	Approx. 10 years, depending on the setting		
Battery status view:	message to the server		
Setting			
Setting:	With a message from the server, magnetic keys, RFAF/USB Service Key		
Measured values:	message to the server		
Detection			
Detection principle:	magnetic		
Detection distance:	0 - 50 cm		
Theft detection:	yes		
Temperature measurement:	yes		
Input			
Temperature measuring:	built-in sensor		
Range:	-30 .. 85 °C		
Sensitivity:	1 °C		
Accuracy:	± 3 °C		
Communication			
Protocol:	iNELS RF Control		
Transmitter frequency:	868.5 MHz		
Range in open space:	up to 100 m		
Protocol:	Sigfox	LoRa	NB-IoT
Transmitter frequency:	RCZ1 868 MHz	868 MHz	LTE Cat NB1*
Range in open space:	Approx. 50 km**	Approx. 10 km**	Approx. 30 km**
Transmission power (max.):	25 mW / 14 dBm	25 mW / 14 dBm	200 mW / 23 dBm
Other parameters			
Working temperature:	-30 ... + 85 °C		
Operating position:	Push into the road (ground level)***		
Pressure load:	up to 1 000 kg		
Protection degree:	IP68		
Resistance to external influences:	UV, salt, snow plough		
Dimension:	Ø 87 x 62 mm		
Weight:	432 g		

* Depending on network coverage

** Multiple frequency bands of B1 / B3 / B5 / B8 / B20 / B28

*** Minimum distance from metal objects (canal) – 1m.

Device description

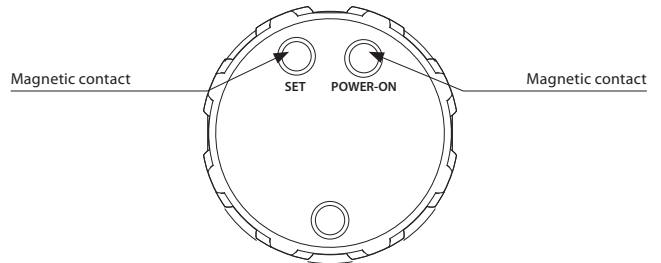
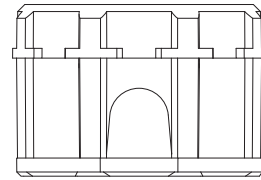

Function

Detects free or busy parking space. To determine the current state, the magnetic principle is used.

Every 4 seconds the sensor scans the free / occupied parking space, and every minute measures the room temperature.

The data message is sent within 120 minutes (can be edited by a message from the server). In the event of a change in status or a sudden change of temperature a message is sent immediately.

Settings: by using supplied magnet (included in the supply).

Detector location

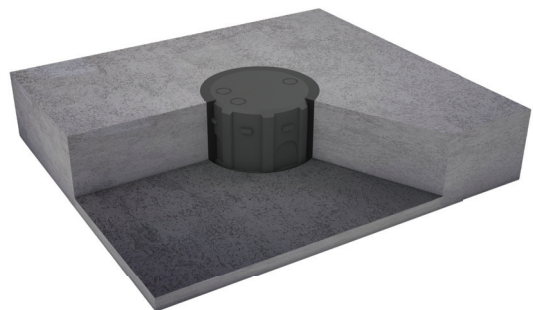



- The sensor informs about the fill volume condition of the container, the waste container, may trigger a requirement to empty it. It also informs you of the actual temperature in the scanning area.
- It has a built-in sensor for opening the lid or for tipping over the waste container.
- With wireless technology and its compactness, the device can be used in a variety of applications.
- Reliable measurement, regardless of material colour, transparency, gloss and interference light.
- With the wireless solution and Sigfox / LoRa / NB-IoT communication, it can communicate instantly to your chosen location and be operated immediately.
- Data is sent to the server from which it can be subsequently displayed as a smartphone, application, or Cloud notification.
- Battery status information is sent as a message to the server.
- Power: 2x Li-SOCl₂ 3.6V (integrated) battery life up to 8 years according to frequency of measurement and message transmission.
- The IP65 is suitable for installation in demanding environments.

Technical parameters	AirWS-100S	AirWS-100L	AirWS-100NB
Power supply	non-removable battery		
Battery power:	2 x Li-SOCl ₂ 3.6V		
Battery life:	up to 8 years according to frequency of measurement and message transmission		
Battery status view:	message to the server		
Setting			
Setting:	With a message from the server, magnetic keys, RFAF/USB Service Key		
Measured values:	message to the server		
Fill detection			
Detection principle:	ultrasonic		
Range:	5 - 300 cm		
Resolution:	1 cm*		
Input			
Temperature measuring:	built-in sensor		
Range:	-30 .. 85 °C		
Sensitivity:	1 °C		
Accuracy:	± 3 °C		
Position detection			
Tilt sensing:	digital sensor		
Angle:	± 180 °		
Accuracy:	± 5 °		
Communication			
Protocol:	iNELS RF Control RFIO**		
Transmitter frequency:	868 MHz		
Range in open space:	up to 20m		
Protocol:	Sigfox	LoRa	NB-IoT
Transmitter frequency:	RCZ1 868 MHz	868 MHz	LTE Cat NB1***
Range in open space:	Approx. 50 km****	Approx. 10 km****	Approx. 30 km****
Transmission power (max.):	25 mW / 14 dBm	25 mW / 14 dBm	200 mW / 23 dBm
Other parameters			
Working temperature:	-30...+85 °C		
Storage temperature:	-30...+85 °C		
Operation position:	sensing contacts downwards		
Mounting:	screws		
Protection degree:	IP65		
Dimension:	Ø 97 x 62 mm		

* Depending on type and content storage

** For service purposes

*** Multiple frequency bands of B1 / B3 / B5 / B8 / B20 / B28

**** Depending on network coverage

Device description

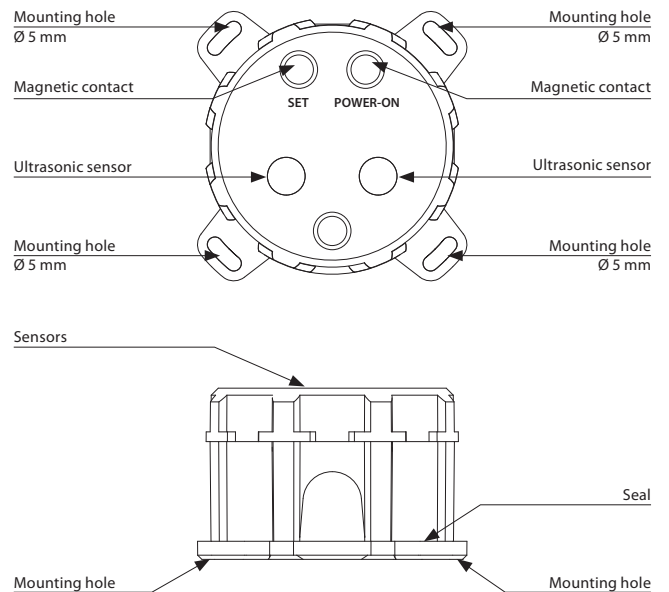

Function

The sensor measures the temperature in the space every minute, simultaneously detects the position of the sensor (e.g. opening the lid, tipping over the waste container, etc.). At twelve hours*, ultrasonic sensors scan the distance between the sensor and the surface being scanned.

Data reports measured values sent in twelve-hour period*. In the case of detecting changes in position of the sensor (opening of the lid, etc.) in 5 minutes*. In the event of a sharp rise in temperature it is reported immediately.

Settings: by using supplied magnet (included in the supply).

* Intervals can be set by message from the server.

AirGTW-FWD | LoRa Gateway FWD for LoRaWAN networks



- LoRa Gateway has the LoRa receiver / transmitter function and the packet forwarder, receives / broadcasts LoRa messages and transmits them to the assigned server.
- LoRa Gateway serves as a transceiver for customers who have their own server solutions.
- The Gateway (or BTS - Based Transceiver Station) serves as a tool to create your own LoRa home network for the Internet of Things.
- It collects requests from end devices, and then transfers them to a pre-determined Server.
- The antenna provides radiation in all directions.
- The gateway is also designed for outdoor use.
- For proper Gateway functionality, you need a connected Ethernet cable and a permanent 48 V DC / PoE power supply.

Technical parameters		AirGTW-FWD
Power supply		
Supply voltage:	48 V DC / active PoE	
Input:	max. 10 W	
Connection		
Connection:	PoE connector with RJ 45 power supply according to the 802.11af standard.	
Communication		
Protocol:	LoRa	
Transmitter frequency:	868,1 MHz, 868,3 MHz, 868,5 MHz	
Signal Strength:	20 dBm	
Encryption:	AES128	
Range in open space:	Approx. 10 km	
Transmission power (max.):	25 mW / 14 dBm	
Hardware		
Baseplate:	Rapsberry Pi 3	
Max. connected nodes:	thousands	
OS:	Linux	
LoRa chip:	Semtech SX-1301 s SX-1257	
Antenna		
Emission:	omnidirectional VGD4	
Material:	high quality fiberglass	
Gain:	8 dBi	
Polarization:	vertical	
Other parameters		
Working temperature:	-20 ... + 60 °C	
Relative humidity:	95 %	
Montage:	on the boom Ø 30-50 mm	
Protection degree:	IP56	
Overvoltage category:	III.	
Pollution degree:	2	
Dimension without antenna:	280 x 213 x 90 mm	
Weight:	1731 g (without antenna)	
Antenna length:	660 mm	
Antenna Weight:	1400 g	

Device description

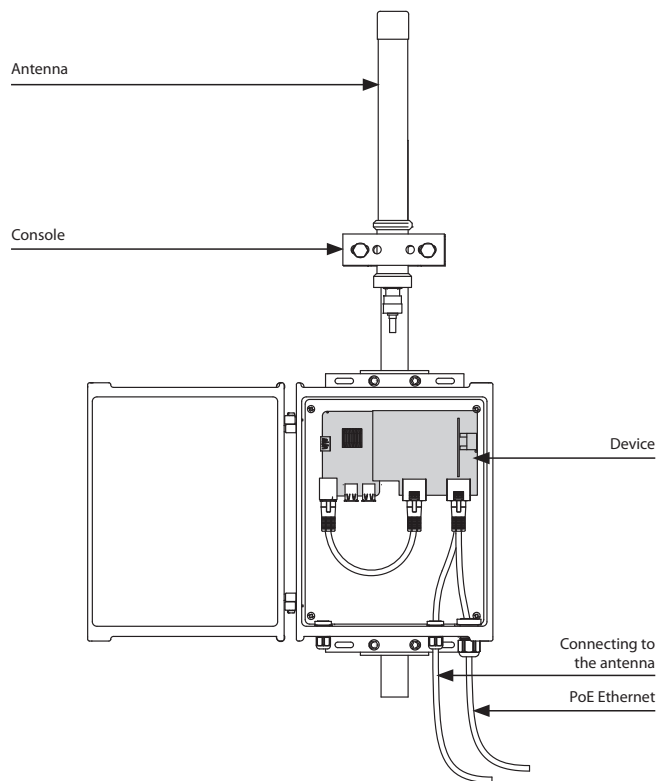



- The LoRa Gateway has the LoRa receiver / transmitter function and the server, receives / transmits messages Lora and processes it on your own server.
- Contains LoRa Network Server (LNS) software for setting and managing end devices.
- By default, the server is open and unsecured - it is designed for further customer integration.
- The Gateway (or BTS - Based Transceiver Station) serves as a tool to create your own LoRa home network for the Internet of Things.
- It collects requests from end devices, and evaluates them.
- The LoRa Gateway Server can be assigned to thousands of IoT terminal devices communicating on this network.
- Assignment of end devices is done through a web portal, which then records all requirements from individual sensors.
- The antenna provides radiation in all directions.
- The gateway is also designed for outdoor use.
- For proper Gateway functionality, you need a connected Ethernet cable and a permanent 48 V DC / PoE power supply.

Technical parameters		AirGTW-LNS
Power supply		
Supply voltage:	48 V DC / active PoE	
Input:	max. 10 W	
Connection		
Connection:	PoE connector with RJ 45 power supply according to the 802.11af standard.	
Communication		
Protocol:	LoRa	
Transmitter frequency:	868,1 MHz, 868,3 MHz, 868,5 MHz	
Signal Strength:	20 dBm	
Encryption:	AES128	
Range in open space:	Approx. 10 km	
Transmission power (max.):	25 mW / 14 dBm	
Hardware		
Baseplate:	Rapsberry Pi 3	
Max. connected nodes:	thousands	
OS:	Linux	
LoRa chip:	Semtech SX-1301 s SX-1257	
Antenna		
Emission:	omnidirectional VGD4	
Material:	high quality fiberglass	
Gain:	8 dBi	
Polarization:	vertical	
Other parameters		
Working temperature:	-20 ... + 60 °C	
Relative humidity:	95 %	
Montage:	on the boom Ø 30-50 mm	
Protection degree:	IP56	
Overvoltage category:	III.	
Pollution degree:	2	
Dimension without antenna:	280 x 213 x 90 mm	
Weight:	1731 g (without antenna)	
Antenna length:	660 mm	
Antenna Weight:	1400 g	

Device description

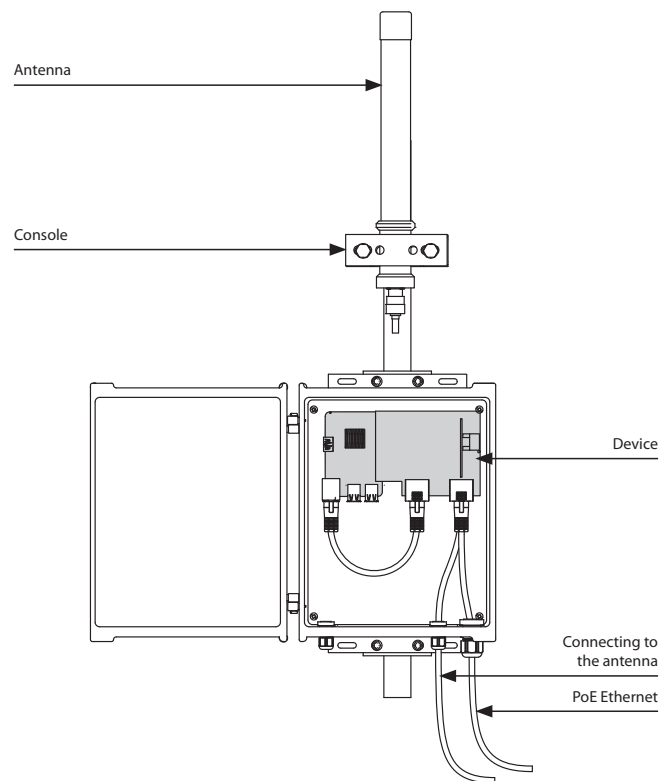

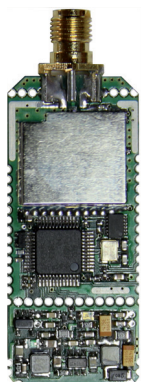

- An existing installation (OEM) module
- Is used to communicate existing devices through the LoRa network
- The function of the device is programmed as required
- Power supply: 5-24 V DC, after breaking the 3 V DC / 140 mAh source section (via linear stabilizer)
- Communication:
 - SPI 1x
 - Analog pins 8x (12-bit)
 - USART 1x
 - I / O digital pins 29x
- Optional antenna connection:
 - SMT Ultra-Miniature Coaxial Connector
 - SMA connector
 - by soldering (the antenna is part of the device to which the module is connected)
- Dimensions**:
 - with ULF connector - 19.5 x 46.1 x 4 mm
 - with SMA connector - 19.5 x 57 x 7 mm
 - with internal antenna - 19.5 x 46.1 x 21 mm

Technical parameters		LoRaWAN Modul OEM
Supply voltage:	5 - 24 V DC / 3V3 140 mAh	
Supply voltage tolerance:	+10 /-15 %	
Setting		
Setting:	With a message from the server	
Indication		
Indication:	blau LED	
Communication		
Protocol:	LoRa	
Transmitter frequency:	868 MHz	
Range in open space:	Approx. 10 km*	
Transmission power (max.):	25 mW / 14 dBm	
Other parameters		
Working temperature:	-15 ... + 50 °C	
Operation position:	any	
Mounting:	soldering	
Antenna output by application:	ULF connector	
Dimension:	19.5 x 46.1 x 4 mm**	
Weight:	13.6 g	
Antenna output AN-I or AN-E:	SMA connector***	
Dimension:	19.5 x 57 x 7 mm**	
Weight:	15 g	
Dimension:	19.5 x 46.1 x 21 mm**	
Weight:	13.5 g	

* Depending on network coverage

** Dimension after breaking source parts

*** Max Tightening Torque for antenna connector is 0.56 Nm.

Accessories

AirKey | Key chain iNELS Air



- It is used to deactivate the motion detector when you enter the monitored area.
- One detector can be matched up to 32 key fobs. The key fob can be paired with any number of detectors.
- Designed in black and white with laser printing.
- Battery power supply (3V/CR2032 - included in the supply) with battery life of around 5 years based on frequency of use.

Technical parameters	AirKey/W	AirKey/B
Supply voltage:	3 V battery CR 2032	
Transmission indication:	red LED	
Number of buttons:	4	
Communication		
Protocol:	iNELS RF Control RFIO	
Transmitter frequency:	868 MHz	
Range in open space:	up to 100 m	
Signal transmission method:	unidirectionally addressed message	
Other parameters		
Operating temperature:	-10 ... +50 °C	
Operating position:	any	
Color:	white	black
Protection:	IP20	
Contamination degree:	2	
Dimensions:	64 x 25 x 10 mm	
Weight:	10 g (without battery)	

Description

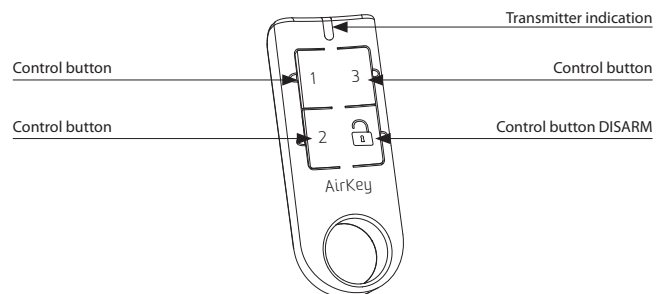

RFAF/USB | Service Key

Technical parameters	RFAF/USB
Power:	max. 1W
Interface:	USB 1.1 and higher, plug. „A“
Range:	100 m
Min. distance of RF	
Touchactuator:	1m
Frequency:	866 MHz, 868 MHz, 916 MHz
Power supply indication:	green LED
RF communication indication:	red LED
Other parameters	
Operating temperature:	0 .. +55°C
Storage temperature:	- 20 .. +70°C
Protection:	IP30
Contamination degree:	2
Work space:	any
Installation:	any
Dimensions:	22 x 85 x 15 mm
Weight:	20 g
Related standards:	EN 60950-1



- The RFAF/USB Service Key (in conjunction with the RF_analyzer) is designed for iNELS RF Control system partners and serves for:
 - Setting the repeater (signal amplifier) through the iNELS RF Control elements labeled as RFIO². This option allows you to communicate over longer distances (in the order of 50 m) via existing iNELS RF Control elements in the installation (eliminating the use of the RFRP-20 repeater).
 - upgrade of firmware in the iNELS RF Control elements (labeled RFIO²), in the case of new firmware versions that improve the functionality of the elements on which we are constantly working.
 - The RF Network Analyzer will reliably analyze the communication between the controller (where you plan to place it) and the component in the installation. Indicates signal strength / quatty as well as possible frequencies that can interfere with communication.
 - sw RF analyzer can be found at inels.com/partners in section SW/FW RF Control

Accessories

TC, TZ | Thermo sensors



EAN code	
TC-0: 8595188110075	TZ-0: 8595188140591
TC-3: 8595188110617	TZ-3: 8595188110600
TC-6: 8595188110082	TZ-6: 8595188110594
TC-12: 8595188110099	TZ-12: 8595188110587

Technical parameters	TC	TZ
Range:	0..+70 °C	-40..+125 °C
Scanning element:	NTC 12K 5 %	NTC 12K 5 %
In air/ in water:	(τ65) 92 s / 23 s	(τ65) 62 s / 8 s
In air/ in water:	(τ95) 306 s / 56 s	(τ95) 216 s / 23 s
Cable material:	High temperature PVC	Silicone
Terminal material:	High temperature PVC	Nickel plated copper
Protection degree:	IP67	IP67
Insulation:	-	-

Types of temperature sensors

	TC-0	TZ-0
- length:	100 mm	110 mm
- weight:	5 g	4.5 g
	TC-3	TZ-3
- length:	3 m	3
- weight:	108 g	106 g
	TC-6	TZ-6
- length:	6 m	6 m
- weight:	213 g	216 g
	TC-12	TZ-12
- length:	12 m	12 m
- weight:	466 g	418 g

τ65 (95): time, which sensor needs to heat up on 65 (95) % of ambient temperature of environment, in which is located.

- Thermister temperature sensors are made of Negative Temperature Coefficient (NTC) embedded in a PVC or metal sleeve with a thermal-conductive sealer.
- Sensor TC
 - lead-in cable to sensor TC is made of wire CYSY 2D x 0.5 mm / 0.02".
- Sensor TZ
 - cable VO3SS-F 2D x 0.5 mm / 0.02" with silicone insulation for use in high temperature applications.
 - silicone insulation for use in high temperature applications.
- Temperature sensors can be connected directly to the terminal block
- Cable lengths can not be changed, connected or modified.

Resistive values of sensors in dependance on temperature

Temperature (°C)	Sensor NTC (kΩ)
20	14.7
30	9.8
40	6.6
50	4.6
60	3.2
70	2.3

Tolerance of sensor NTC 12 kΩ is ± 5% by 25 °C / 77°F.

Diagramm of sensor warm up via air

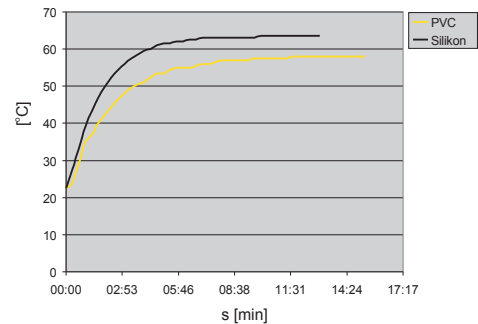

PVC - reaction to water temperature from 22.5 °C to 58°C.
Silicone - reaction to water temperature from 22.5°C to 63.5°C.

HTML2500LF | Temperature and humidity sensor



Technical parameters	HTML2500LF
Operating temperature:	- 40 .. + 85 °C
Relative humidity:	1 % .. 99 %
Humidity measurement accuracy:	± 3 %
Supply voltage:	5 V
Dimensions:	326 mm
Weight:	17.5 g

Accessories

LS, MS, WS | Sensors



EAN code
 LS: 8595188155762
 MS: 8595188155779
 WS: 8595188157940

Technical parameters	LS	MS	WS
Working temperature:		-20 .. +50°C	
Cross-section of connecting wires:		max. 3.5 mm	
Wire length:		1.5 m*	
Protection:		IP65	

* the standard supplied length of 1.5m can be custom ordered in an extended version of up to 5 m.

LS (LED sensor):

- The LED sensor scans LED impulses on the meter, which indicates consumption by flashing.
- The LED sensor is particularly suitable for power meters that support LED pulse sensing (the LED on the meter is marked "imp").
- The sensor's scanner is affixed with glue above the LED diode of the meter signaling indication of consumption.

MS (Magnetic sensor):

- The magnetic sensor scans movement of the numeral, upon which a permanent magnet is placed.
- The MS sensor is particularly suitable for gas meters that support magnetic sensing.
- The sensing sensor is glued over the last number of the face dial measured.

WS (magnetic sensor water meter):

- A magnetic sensor that detects the pulse that is created by each rotation of the magnet placed on the unit dial meter.
- The WS sensor is especially suitable for water meters that support magnetic sensing.
- The sensing sensor is glued over the circular unit face of the gauge (the scanning dial is different from the other indicators, e.g. the white arrow wheel).

AN-I | Internal antenna



- into plastic switchboard
- rod angle, without cable
- sensitivity 1 dB
- the internal antenna is included in the standard package

EAN code
 Internal antenna AN-I: 8595188161862

AN-E | External antenna



- for mounting into metal switchboard
- cable length 3 m
- sensitivity 5 dB
- the external antenna AN-E is supplied on request only

EAN code
 External antenna AN-E: 8595188190121

FP-1 | Flood probe



EAN code
 FP-1: 8595188147064

Technical parameters	FP-1
Working temperature:	-10 .. +40 °C
Mounting:	glue
Length of cable:	3 m
Dimensions:	60 x 30 x 8 mm
Related standards:	EN 50130-4, EN 55022

Product dimension

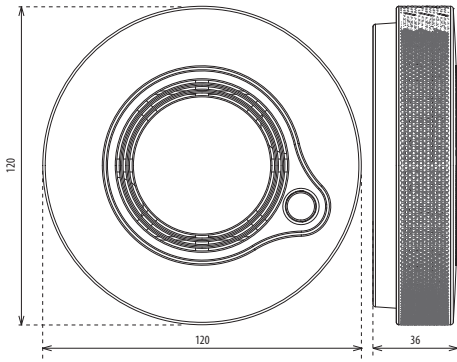

AirSD-100, AirQS-100, AirQS-101

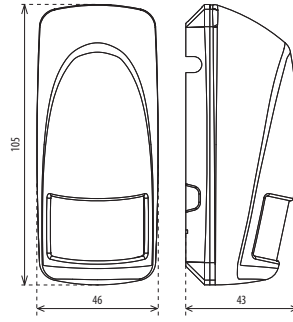

AirMD-100

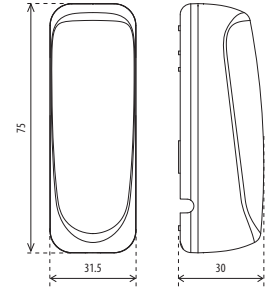

AirWD-100

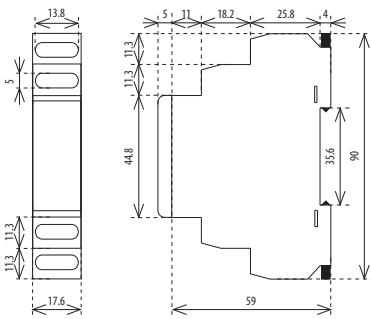

AirIM-100x/M

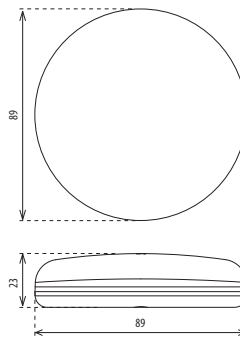

AirSF-100

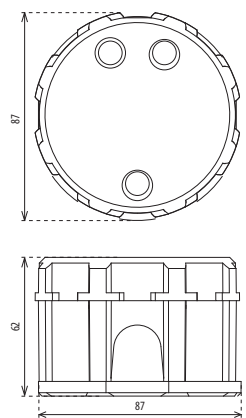

AirPD-100

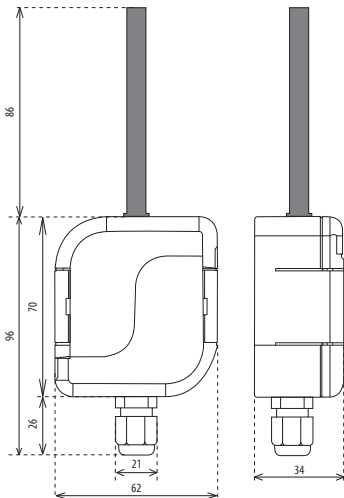

AirIM-100, AirTM-100
AirSOU-100, AirSLC-100

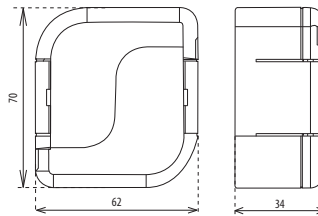

AirWD-101

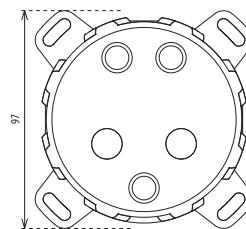

AirWS-100

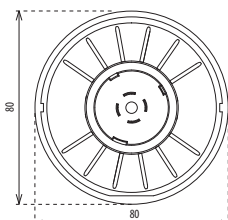
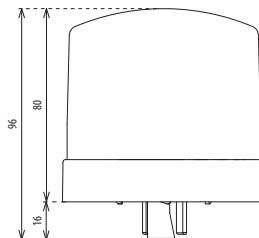
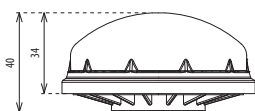

AirSLC-100/LWES

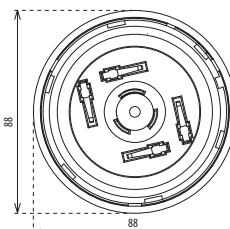

AirSLC-100/NEMA

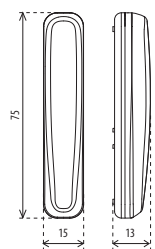

D/WD

General instructions

Internet of Things (IoT)

- The IOT wireless communications category describes the Low Power Wide Area (LPWA). This technology is designed to provide full-range coverage both inside and outside buildings, energy-saving and low-cost operation of individual devices. Individual networks - Sigfox, LoRa, NarrowBand - are available to use this standard.

Sigfox network information

- The network supports bidirectional communication but with a limited number of feedbacks. It uses the free frequency band divided by Radio Frequency Zones (RCZ).
 - RCZ1 (868 MHz) Europe, Oman, South Africa
 - RCZ2 (902 MHz) North America
 - RCZ3 (923 MHz) Japan
 - RCZ4 (920 MHz) South America, Australia, New Zealand, Singapore, Taiwan
- Sigfox has more coverage across countries, so it is better suited for long distance monitoring.
- For more information on this technology, please visit www.sigfox.com.

LoRa network information

- The network is bidirectional and its communication uses free frequency band.
 - 865 - 867 MHz India
 - 867 - 869 MHz Europe
 - 902 - 928 MHz North America, Japan, Korea
- The advantage of this network is the possibility of freely deploying individual stations in local locations, thus strengthening their signal. It can therefore be used efficiently in company premises or, for example, in local parts of cities.
- For more information on this technology, please visit www.lora-alliance.org.

Information about the NarrowBand network

- The network provides two-way communication and the only one to use the licensed LTE band. Our devices allow band 1 (2100MHz), Band 3 (1800MHz), Band 8 (900MHz), Band 5 (850MHz), Band 20 (800MHz) and Band 28 (700MHz).
- It uses this SIM card technology for each device.
- The advantage of NarrowBand is the use of already built-up grids, which ensures sufficient reception outside and inside buildings.
- For more information on this technology, please visit www.vodafone.cz

Caution for proper operation:

- Products are installed according to the wiring diagram given for each product.
- For proper device functionality, it is necessary to have sufficient coverage of the selected network at the installation site.
- At the same time, the device must be registered in the network. Successful device registration on a given network requires a charge for traffic.
- Each network offers different tariff options - it always depends on the number of messages you want to send from your device. Information on these tariffs can be found in the current version of the ELKO EP pricelist.

Sensors



LED sensor

LS

- senses pulses from gauges that use LED flashes for indication
- the sensor is placed outside the meter by fixing it to the appropriate location



Magnetic sensor

MS/WS

- detects the magnetic pulses that are generated by turning the indicator on / off of the gauge dial
- the sensor is placed outside the meter by fixing it to the appropriate location

Pulse output

SO

- meter with pulse output marked as "SO" connected by wires to connectors GND and DATA1 located on AirTM-100

Actuators

Lighting control



Probes

FP-1, NL-100

- FP-1 - Flood probe
- NL-100 - Plastic float sensor



Key chain iNELS Air

AirKey

- it is used to deactivate the motion detector when you enter the monitored area
- one detector can be matched up to 32 key fobs. The key fob can be paired with any number of detectors
- battery power supply (3V/CR2032 - included in the supply) with battery life of around 5 years based on frequency of use



Street light controller (DALI)

AirSLC-100L/DALI,
Air SLC-100NB/DALI

- lighting switching and control
- DALI communication with ballast is used to control light intensity (alternatively 0-10V)
- continuous power supply 110 - 230V AC
- enhanced IP65 protection (dust and splash protection)

Detectors

Motion detection



Motion detector (indoor)

AirMD-100S, AirMD-100L,
AirMD-100NB

- detects people moving in a supervised area
- adjustable detector sensitivity
- battery power



Magnetic detector (indoor)

AirWD-100S, AirWD-100L,
AirWD-100NB

- primarily designed to detect opening / closing windows, doors or gates
- activation occurs by removing the magnet from the sensor
- activation occurs by removing the magnet from the sensor
- battery power



Magnetic detector (outdoor)

AirWD-101S, AirWD-101L,
AirWD-101NB

- primarily designed to detect opening / closing windows, doors or gates
- activation occurs by removing the magnet from the sensor
- status change information is sent to server
- battery power
- enhanced IP65 protection (dust and splash protection)



Temperature sensor

TC

- the sensor is made from a NTC thermistor with a PVC end
- temperature range 0 ... + 70 ° C
- length 100 mm
- weight 5 g



Temperature sensor

TZ

- the sensor is made of an NTC thermistor, which is embedded in metal end cap by heat-conductive putty
- temperature range -40 ... +125 ° C
- length 110 mm
- weight 4.5 g



Combined sensor

HTML2500LF

- measures temperature and humidity
- humidity range 1 ... 99% (± 3%)
- temperature range - 40 ... + 85 ° C
- length 326 mm
- weight 17.5 g



Outdoor street light controller

DALI: AirSLC-100L/LWES/DALI 0-10V: AirSLC-100L/LWES/0-10V
 AirSLC-100NB/LWES/DALI AirSLC-100NB/LWES/0-10V
 AirSLC-100L/NEMA/DALI AirSLC-100L/NEMA/0-10V
 AirSLC-100NB/NEMA/DALI AirSLC-100NB/NEMA/0-10V

- designed to measure light intensity
- DALI or 0-10V communication is used for intensity control
- internal illumination sensor, range 5 - 100,000 Lx
- internal temperature sensor in the range -30 ... 70 ° C
- protection IP66, UV resistant
- power type LUMAWISE ENDURANCE S. (LWES) or NEMA SOCKET (NEMA)



Built-in board

LoRaWAN Modul OEM

- an existing installation (OEM) module
- used to communicate existing devices through the LoRa network
- the function of the device is programmed as required
- power supply: 5-24 V DC, after breaking the 3 V DC / 140 mAh source section (via linear stabilizer)

Liquid detection

Occupancy detection



Gyroscopic detector

AirGYRO-100L, AirGYRO-100NB

- responds to changing its location
- sends a message to the server when it is detected
- battery power
- enhanced IP65 protection (dust and splash protection)



Flood detector

AirSF-100S, AirSF-100L,
AirSF-100NB

- the activation occurs after flooding the bottom contacts on the detector
- battery power
- enhanced IP68 protection

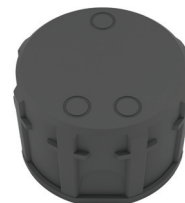

Parking detector

AirPD-100S, AirPD-100L,
AirPD-100NB

- detects a free or occupied parking space utilising the magnetic principle
- data are sent to the server and displayed in a smartphone application or ELKO Cloud
- battery power with a lifetime of about 10 years
- enhanced IP67 protection

Sensors

Smoke detection



Smoke detector

AirSD-100S, AirSD-100L,
Air SD-100NB

- detects smoke, temperature and humidity
- automatic testing of functionality
- battery power
- dimension 120 mm × 36 mm
- weight 176 g

Air quality



Air quality sensor - carbon dioxide (CO₂)

AirQS-100S, AirQS-100L,
AirQS-100NB

- measurement of CO₂
- automatic testing of functionality
- continuous power supply 12-240 V AC / DC
- sensitivity 300 ... 5000 ppm, accuracy 5 % (0 ... 180 ppm)
- dimension 120 mm × 36 mm
- weight 185 g



Air quality sensor - carbon monoxide (CO)

AirQS-101S, AirQS-101L,
AirQS-101NB

- safety device for CO concentration monitoring
- information about the actual temperature and humidity
- battery power
- sensitivity 0 ... 10000 ppm, accuracy 5 % (0 ... 500 ppm)
- dimension 120 mm × 36 mm
- weight 184 g

Lighting control



Twilight sensor

AirSOU-100S, AirSOU-100L,
AirSOU-100NB

- allows you to capture the current lighting intensity and to control the intensity of artificial lighting thanks to this information, thereby reducing power consumption
- battery power
- enhanced IP65 protection (dust and splash protection)

Fill level detection



Ultrasonic fill-level

AirWS-100S, AirWS-100L,
AirWS-100NB

- informs about the filling level of the container, storage tank or garbage cans
- resistance to dirt, dust, moisture and fogging
- battery power
- protection IP65 is suitable for installation in demanding environments

Energy consumption



Pulse transmitter

AirTM-100S, AirTM-100L,
AirTM-100NB

- wireless pulse transducer designed for sensing pulses from energy meters (electricity meters, gas meters, water meters)
- information about pulse counts (consumption) is sent to the server
- battery power
- enhanced IP65 protection (dust and splash protection)

Monitoring



Universal input

AirIM-100S, AirIM-100L,
AirIM-100NB

- used to measure temperatures, humidity, voltage, current, voltage according to the sensor used
- battery power / Permanent power supply 5-12 V DC
- enhanced IP65 protection (dust and splash protection)



Universal input (for DIN rail)

AirIM-100S/M, AirIM-100L/M

- in conjunction with the relevant monitoring relay, monitors the current status of the appliances and detects critical and emergency states
- 24-240 V AC power supply in the cabinet design
- in 1-MODULE design, rack-mount

Monitoring relay



Relevant monitoring relay

- catalogue sensors and monitoring relays

IoT Networks

This term includes the concept of connecting appliances, machines, sensors to an existing internet structure. This structure utilizes a specially designed network for small data transfer and low power consumption over long distances. For our concept, we use the Sigfox, LoRa and NB-IoT networks.

Data from the device is sent via the BTS to the control server from where it is sent to the ELKO Cloud network. Depending on user requirements, data may be sent to a smartphone application or integrated into the main system.

iNELS Air was designed in response to the dynamically developing networks for IoT. This technology is designed to provide full coverage, is energy-saving and has low operating costs.

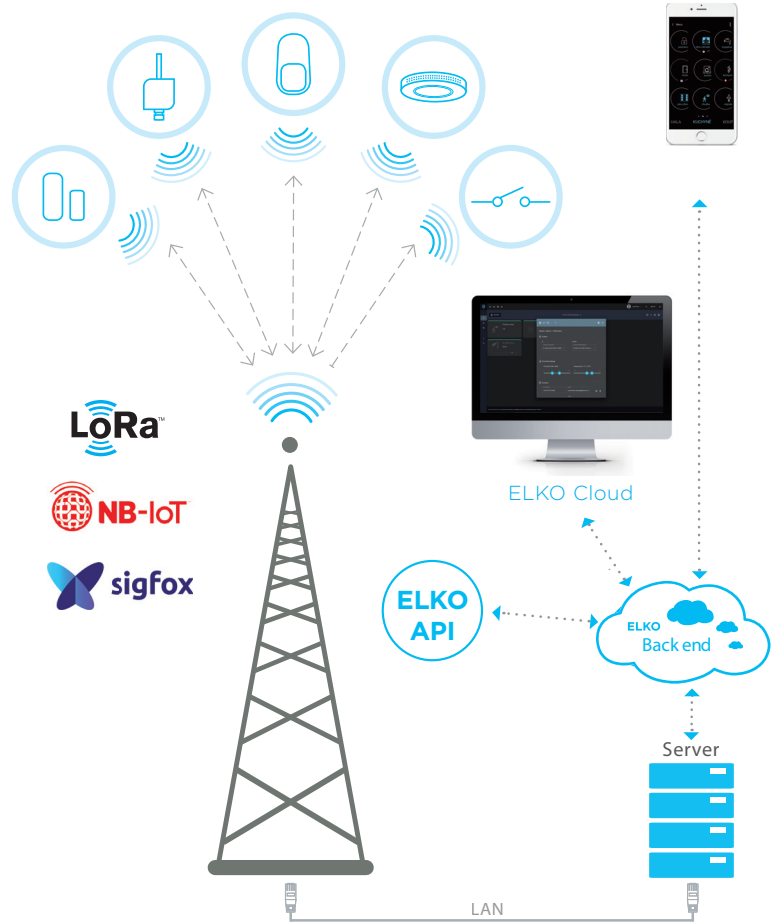

	sigfox	LoRa	NB-IoT
Low purchase price	●	●	●
Extended battery life	●	●	●
Degree of coverage of areas	●	●	●
Wide indoor coverage	●	●	●
Bandwidth of 868 MHz	●	●	●
Two-way communication	●	●	●
Create your own network	●	●	●
Upgrade your own network	●	●	●
Cellular security	●	●	●
Roaming	●	●	●
Function without SIM card	●	●	●
Backend (B2B)	●	●	●
Custom Portal (B2C)	●	●	●

Others just resell

HOWEVER, WE DEVELOP AND MANUFACTURE PRODUCTS OURSELVES!

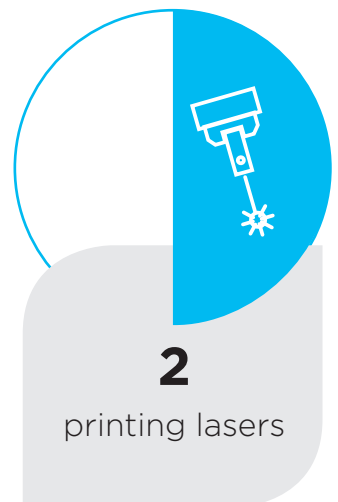
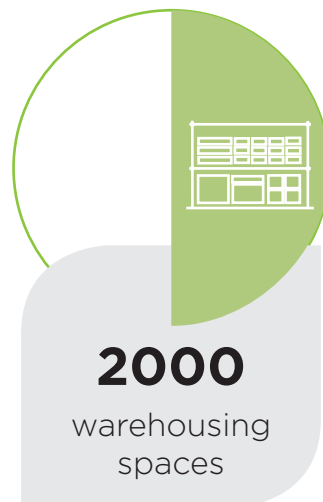
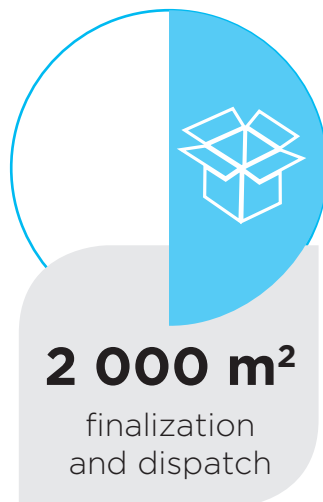
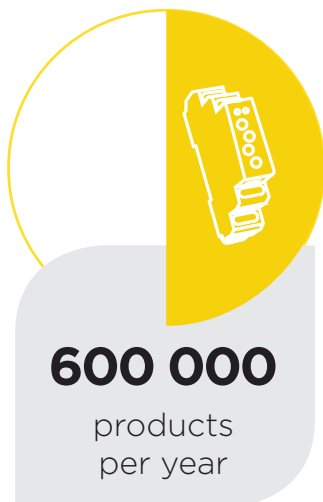
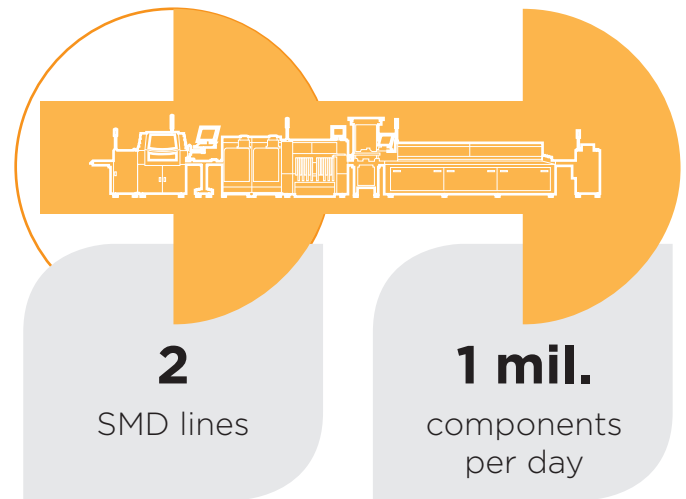
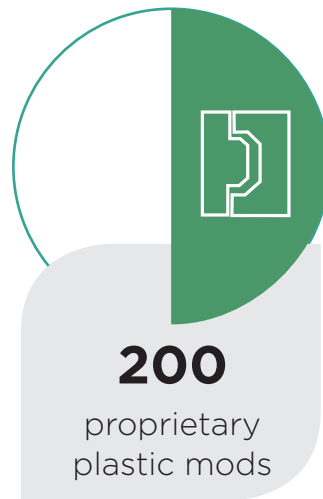
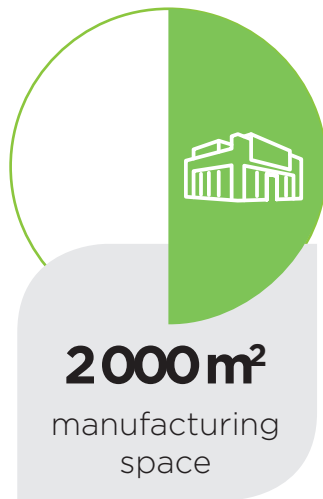
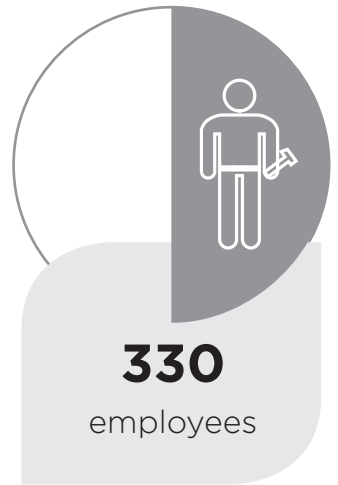
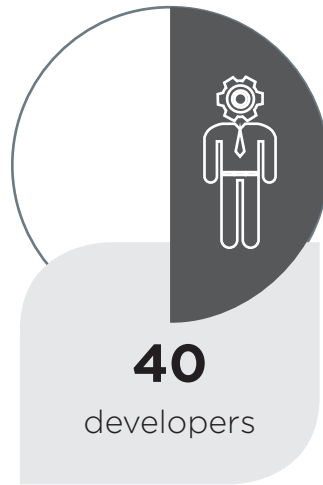

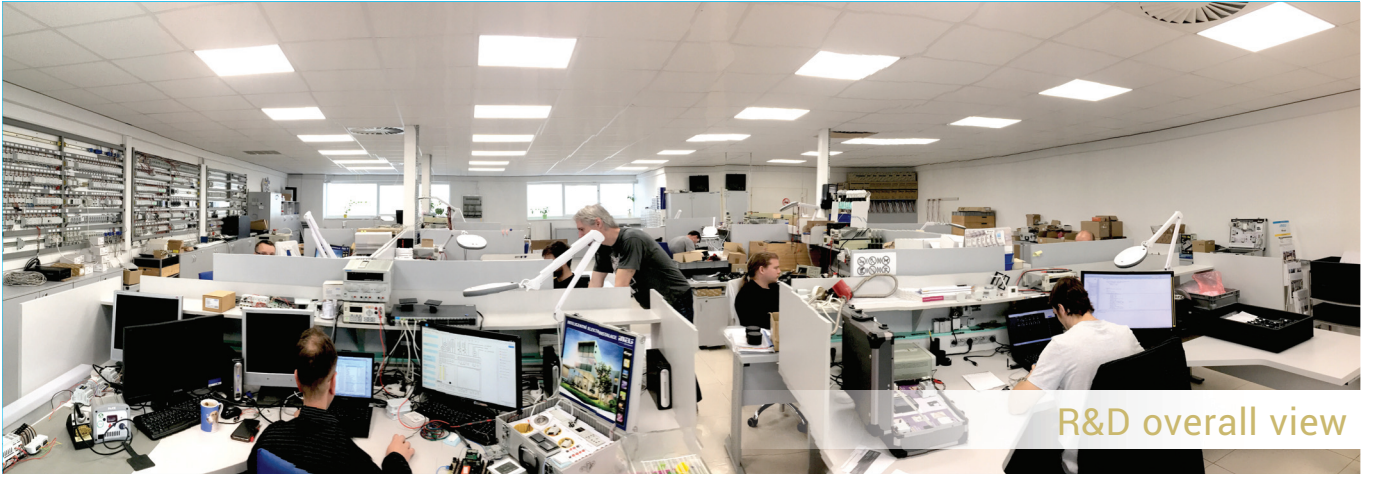

ELKO EP Holding



www.elkoep.com

Published: 02/2019 | 1st edition
Modifications or amendments reserved.