



**„ALWAYS SOMETHING MORE!“**





## WE ARE



### DEVELOPERS

In the new R&D center, more than 30 engineers develop new products and extend the functionality of existing products.

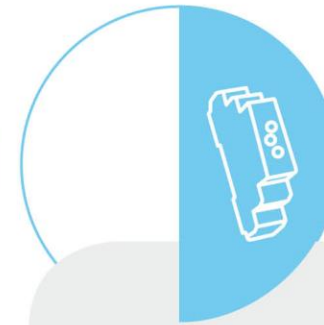

### PRODUCERS

Modern antistatic spaces, 2x fully automated SMD production lines, 2 shift operations.



### SUPPORT

24 hours / 7 days / 360 days we not only provide technical support but also logistics.



### SELLERS

Personal access to more than 70 sales representatives in ELKO EP Holding provides impeccable services and superior products at an affordable price.

# Development · Production · Sellers · Support

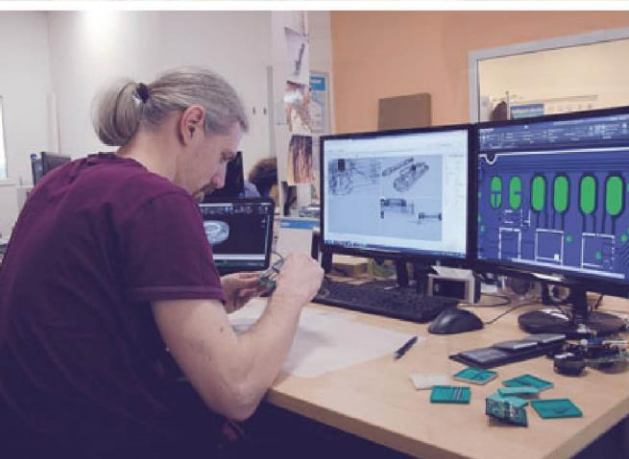
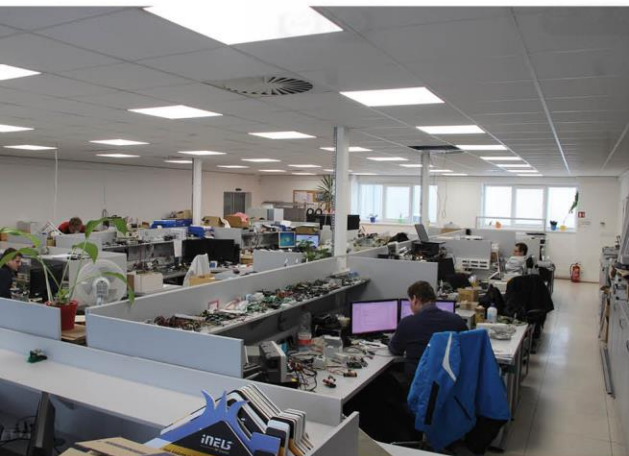

# Key numbers



**26 years**

on the market



**15 years**

ISO certification



**40**

developers



**330**

employees



**2000m<sup>2</sup>**

manufacturing  
space

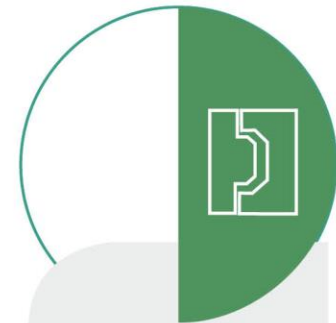

**200**

proprietary  
plastic mods

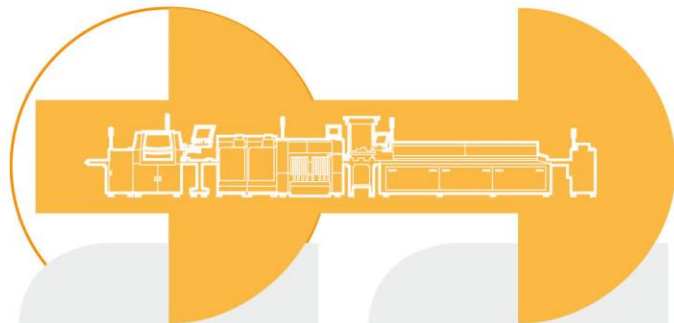

**2**

SMD lines

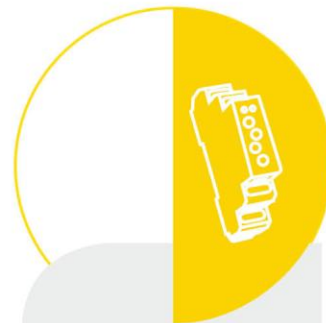

**1 mil.**

components  
per day



**600 000**

products  
per year



**2000m<sup>2</sup>**

finalization  
and dispatch



**2000**

warehousing  
spaces



**2**

printing lasers

# We are developers as well as producers

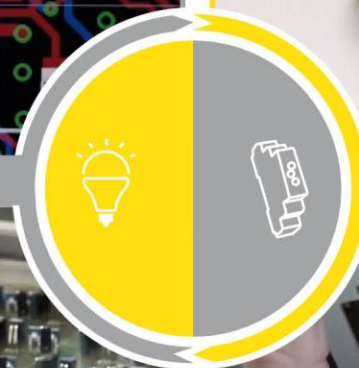
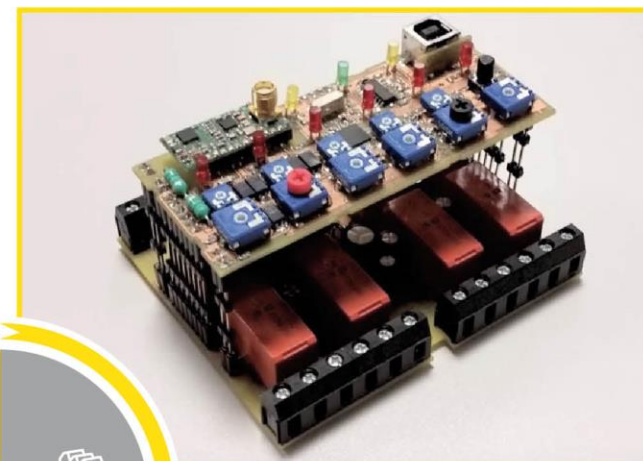
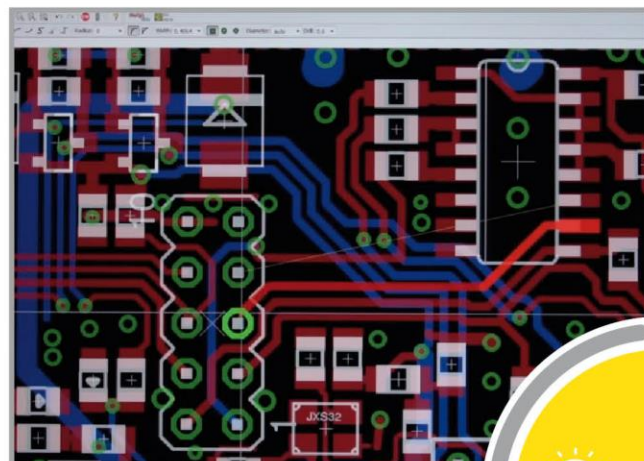
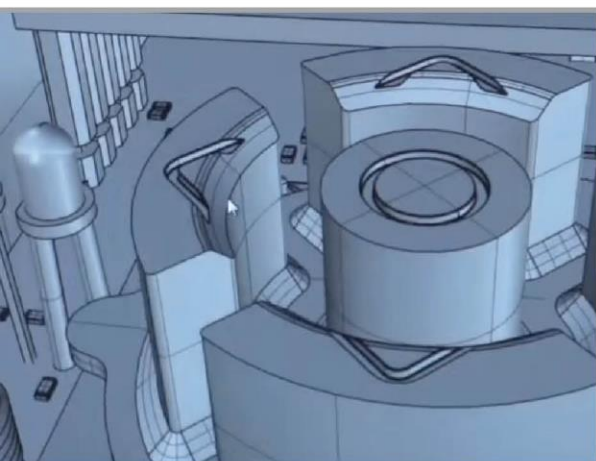

## LARA – Radio & Music & Intercom

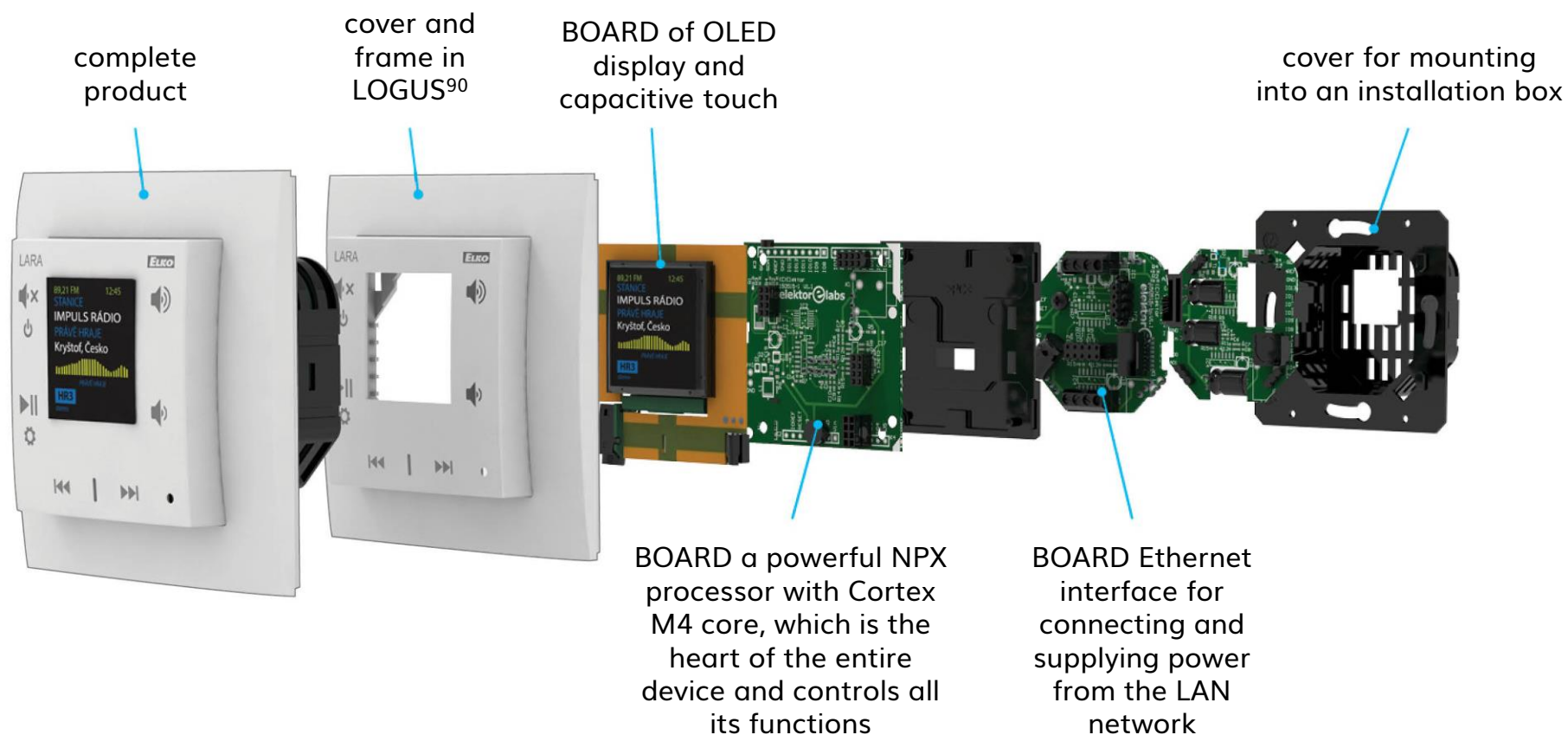

## Corporate awards



**Jiří Konečný**  
The Entrepreneur  
of the year 2004



**Company**  
of the year 2012



**Visionaries**  
2015



**ELKO EP Company** ranked  
among the 100 best  
Czech companies



**Global exporter**  
2016



**Jiří Konečný**  
Personality of  
Smart City 2017

## Product awards



**Golden product** for  
„SMR-T“

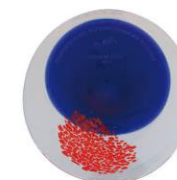

**ELA awards** for  
„RF Touch“



**The honorable mention**  
for „iNELS RF Control“



**Golden Amper** for  
„wireless electro-installation“



**Czech electro  
association awards**  
for „LARA“



**Awards for**  
„Smart RF Box“

## Associations



## Product compatibility

### BUS



### BMS



# ELKONET



## Wireless



## LPWAN



## Buildings and Industry



# iNELS integrate 3<sup>rd</sup> party devices



## Cameras



## Air conditioning



## Other



## Security





**OUR QUALITY**

# Most famous OEM brands proof our quality



- Contemporary R&D
- In-House production
- Hi-Tech Technology
- Antistatic area

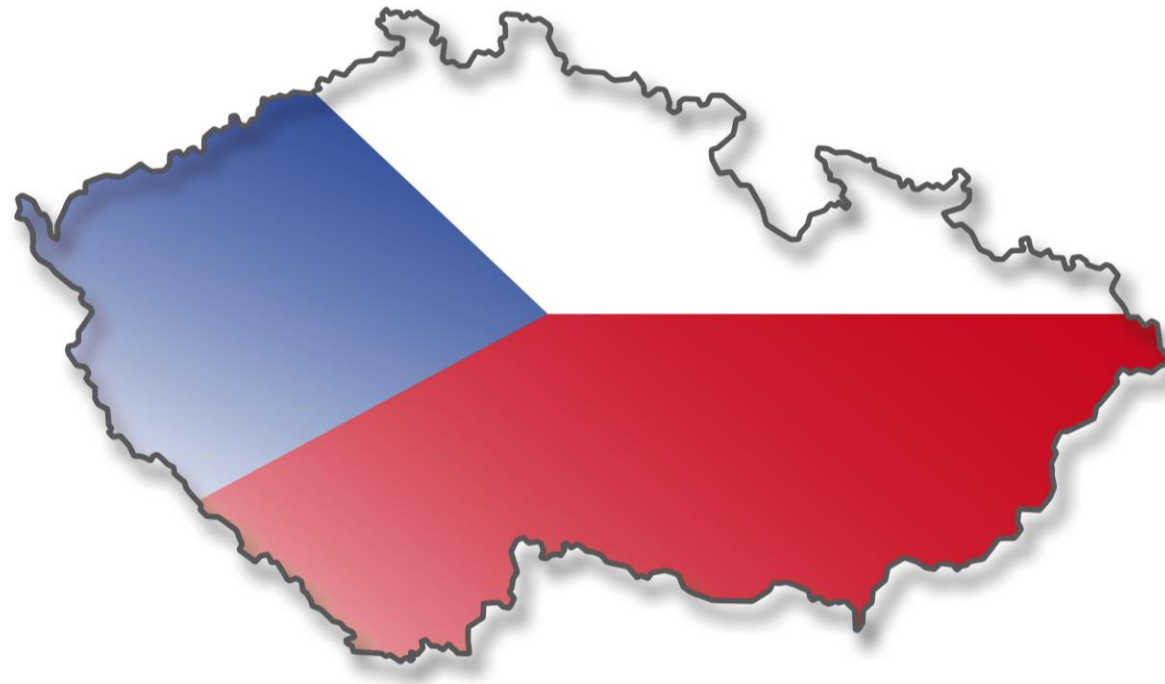

## The Unique Serial Numbers

- Serial numbers are assigned when the product is started up
- Serial numbers are loaded after each operation
- Data is stored on-line for a specific serial number
- Records from data can be loaded at any time
- If the product is in the unprinted state, the serial number is it's only identifier

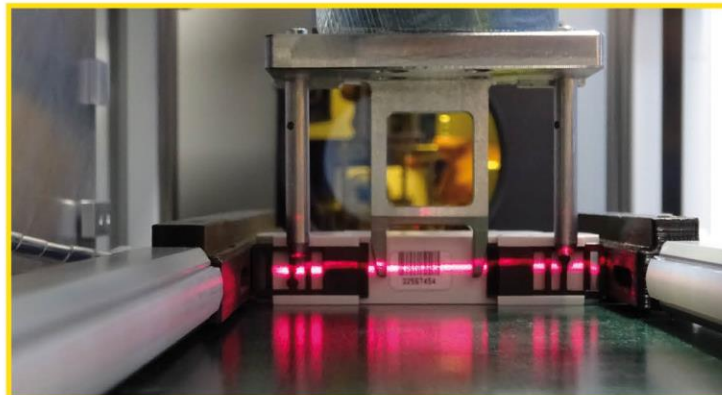
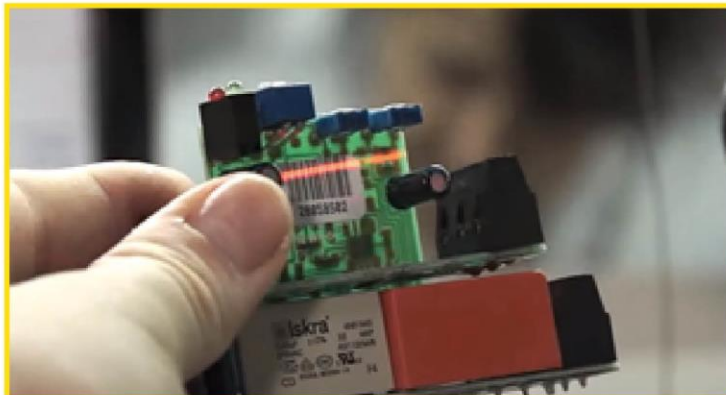
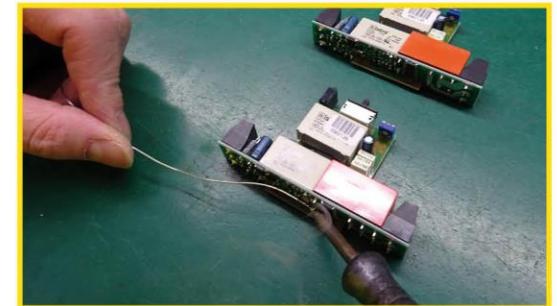
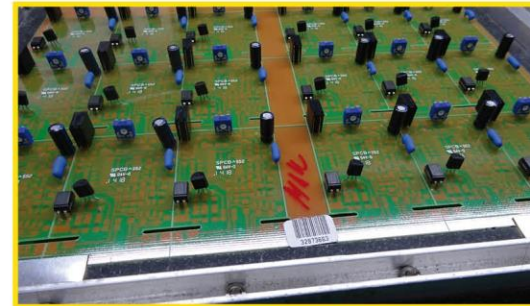
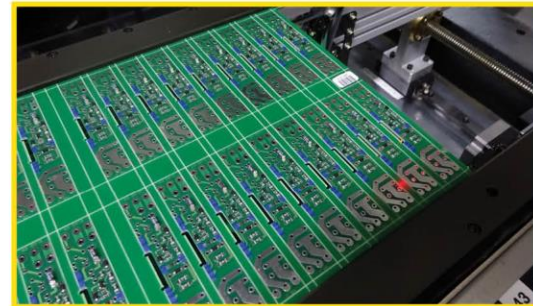

## ELKO EP

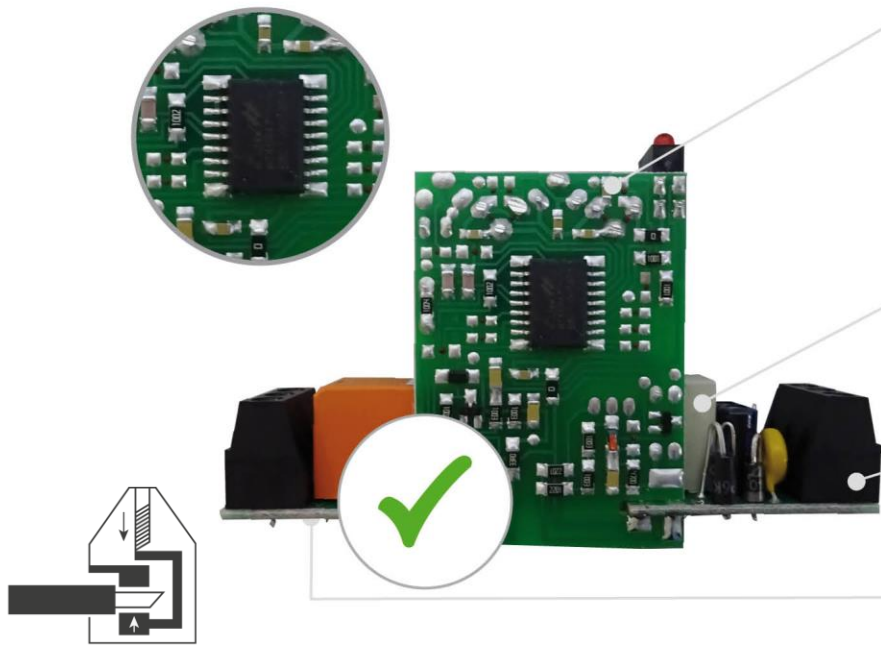

**Technology**  
SMD || Classic

**Components**  
quality || cheap

**Terminals**  
16A UL || 10A

**Capacitors**  
up 105° || up 90°

- Output relay connected on board
- Power circuits switched power supply
- Power voltage UNI (12... 240 V AC/DC)
- Components – mostly SMD

## Low cost

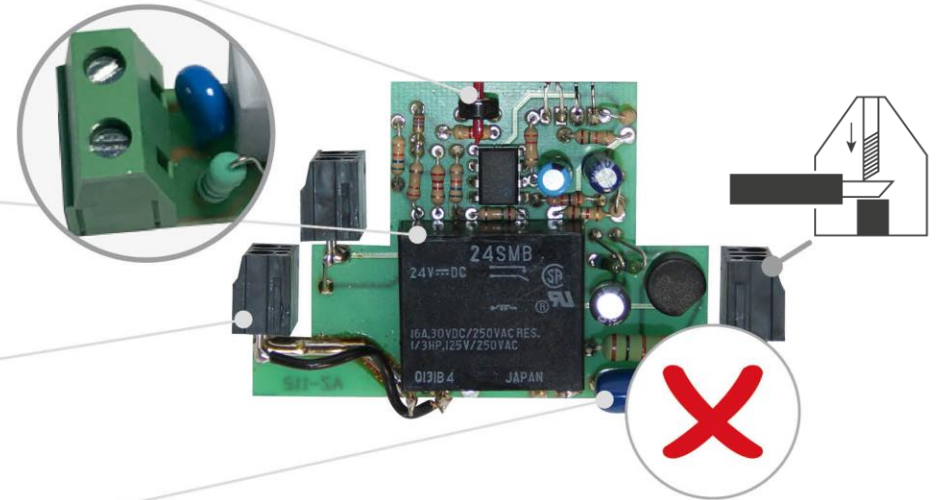

- Simply power supply protecting against voltage fluctuation
- Relay 16 A which is connected on terminals via wire with max current 6 A
- Power voltage 230 V AC
- Components – mostly SMD

# Quality PCB relay = key component



## Good brand

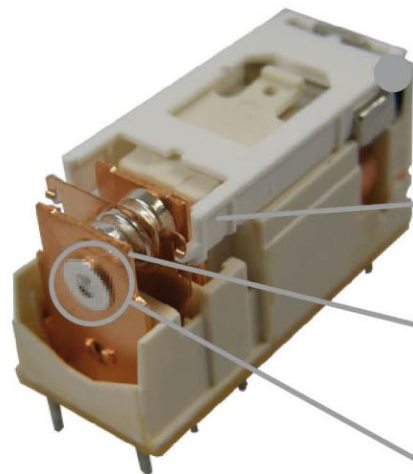

**Mechanical life**  
 $3 \times 10^7$  ||  $1 \times 10^7$

**Insulation**  
4 kV || 2,5 kV

**Contact material**  
 $\text{AgSnO}_2$  || AgNi

powerful contact || small pad

- Contact  $\text{AgSnO}_2$  = resistive, inductive, capacitive load
- 16 A
- Contact is from single material (longer life)
- Mechanical life –  $3 \times 10^7$
- Electrical life –  $1 \times 10^5$

## Low cost

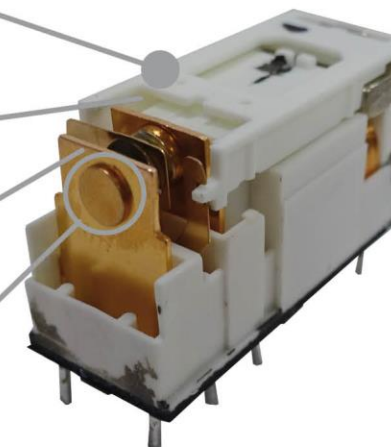

**Mechanical life**  
 $3 \times 10^7$  ||  $1 \times 10^7$

**Insulation**  
4 kV || 2,5 kV

**Contact material**  
 $\text{AgSnO}_2$  || AgNi

powerful contact || small pad

- Contact  $\text{AgNiO}_2$  = resistive load
- 16 A
- Contact is flooded (less life)
- Mechanical life –  $1 \times 10^7$
- Electrical life –  $7,5 \times 10^4$



# Own accredited testing lab



- Certification
- Development tests
- Test of climatic resistance
- Test of dielectric strength, high voltage
- Test of resistance materials: extreme heat, flammability
- Long-term tests
- EMC tests

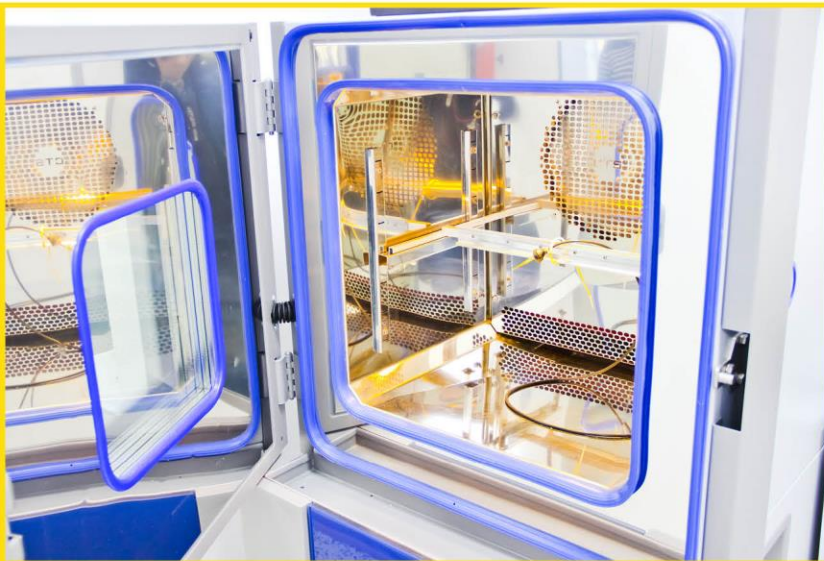



## MOSFET

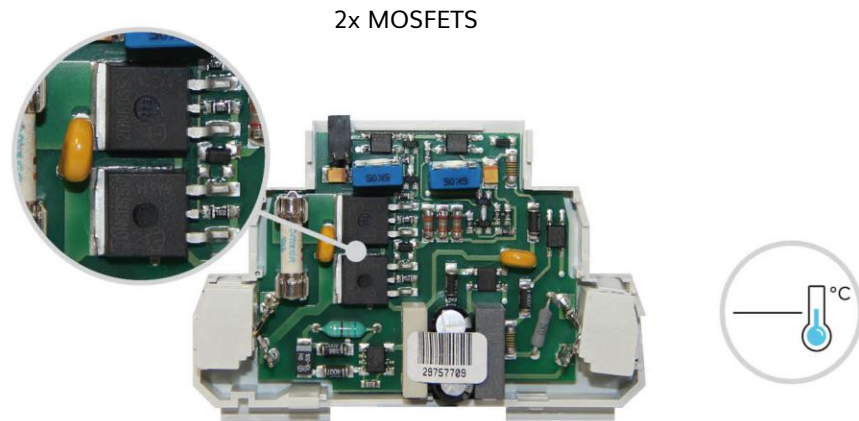

### MOSFET

- Mode On Dimmer or OFF Dimmer (R, L, C)
- Mostly SMD (with power components)
- Maximal use of SMD components (with power components)

## Triac

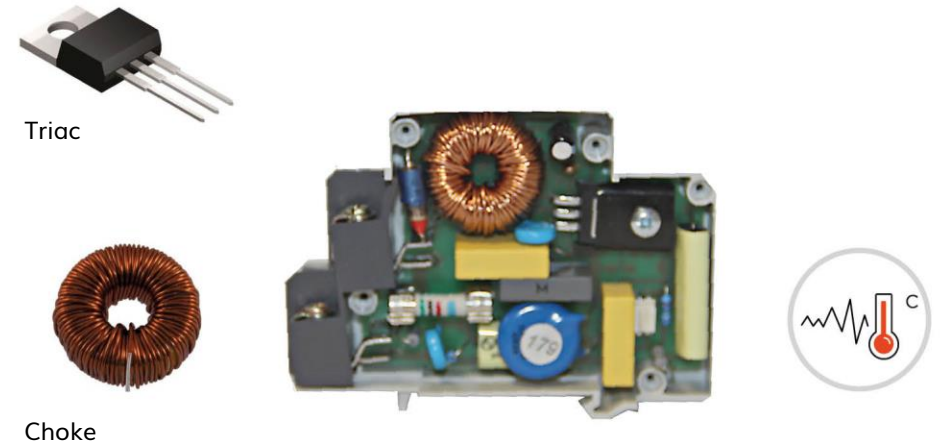

### Triac

- Mode only ON Dimmer (R, L)
- Mostly classic assembly
- Power + protective features – lead components



# OUR PRODUCTS

# Wide portfolio for universal solutions



Timers/Relays



Protecting /Monitoring relays



iNELS Air - IoT devices



Wireless electro-instalation (RF)



Wired electro-instalation (BUS)



Energy management



Hotel wireless Retrofit (HRESK)



Hospitality Hotel (GRMS)



Building Management System



Lighting control



Multimedia



Switches and sockets

# Time relays



## Single-function



Single-function time relays



Timing without power supply  
Two-stage delay unit



Delayed start star/triangle  
Asymmetric cycler

## Multi-function



Multi-function time relay



Time relay with external potentiometer  
Time relay to socket



Super-multifunction relay

## Time Switch clock



Digital switching clock



Switching clock with DCF control  
Switching clock with astr. program  
NFC technology for setting

## Twilight & Level switches



Twilight switch



Level switch

## Auxiliary & Power relays



Auxiliary relays

# Protecting & Monitoring relays



## Voltage



Monitoring voltage relay  
1-phase, AC/DC



Monitoring voltage relay  
1-phase



Relay tracking sequence and failure,  
for 3-phase sewing



Voltage relay for over-voltage/undervoltage  
monitoring in 3-phase networks



Relay for complete control of 3-phase  
networks



Frequency monitoring relay



Monitoring voltage relay

## Current



1-phase monitoring current relay



1-phase monitoring current relay



3-phase monitoring current relay

## cos $\varphi$



Power factor relay  
Relay for frequency control

## Memory relay/USS



Memory relay



Control and signaling modules USS

# iNELS RF Control: Wireless electro-installation



Wireless touch unit  
RF Touch



Wireless temperature controller  
RFTC-100/G



Window / Door detector  
RFWD-100



IP camera  
iNELS Cam



Wireless twilight switch  
RFSOU-1



Universal dimmer  
RFDEL-71B

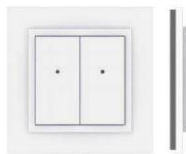

Wireless wall controller  
RFWB-40/G



Wireless remote controller with display  
RF Pilot



Wireless pulse converter  
RFTM-1



Wireless coloured bulb  
RF-RGB-LED-550



Switching socket  
RFSC-71



4 button controller - keychain  
RF Key

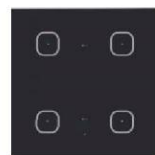

Wireless dimmer switch  
RFDW-71



Smoke detector  
RFSD-100, RFSD-101



Motion detector  
RFMD-100



Wireless thermo-valve  
RFATV-1



# iNELS BUS: Wired electro-installations

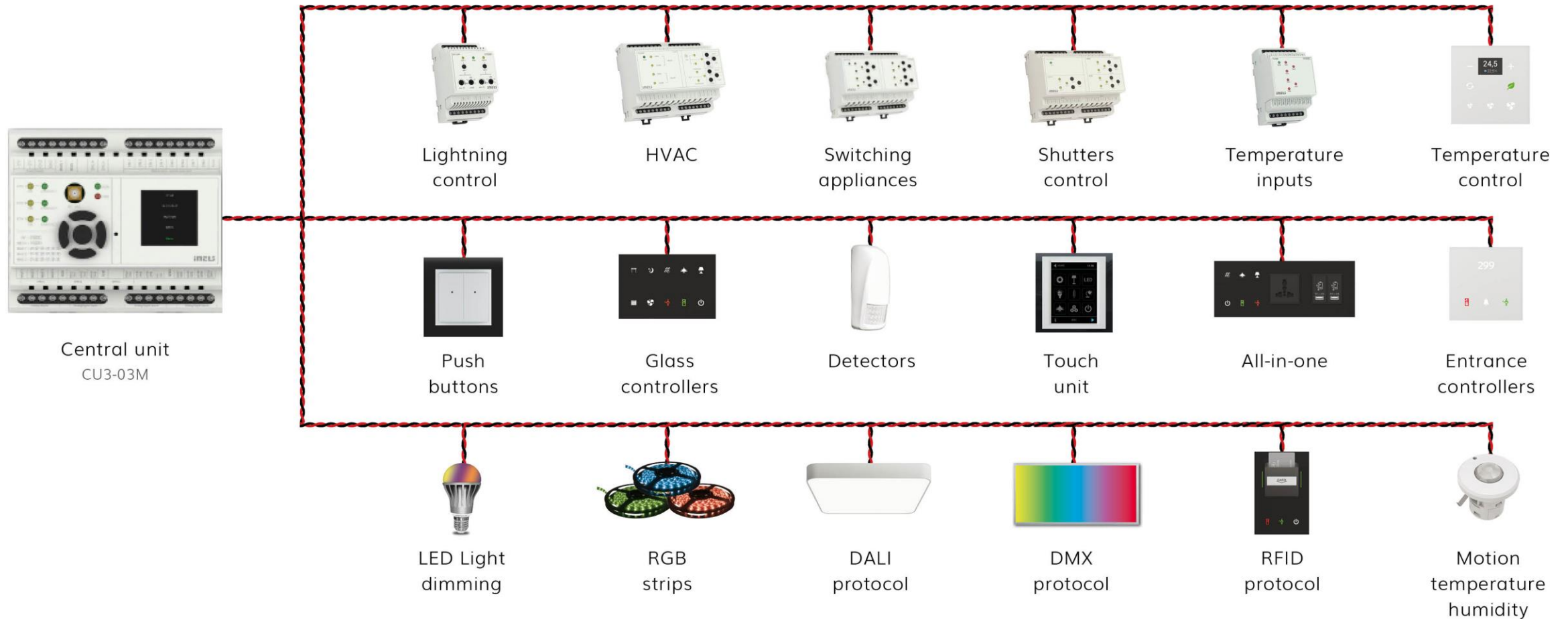

# BMS: Building Management System



powered by  
**niagara**  
framework<sup>®</sup>



**OBIX**

**OPC™**

**XML**

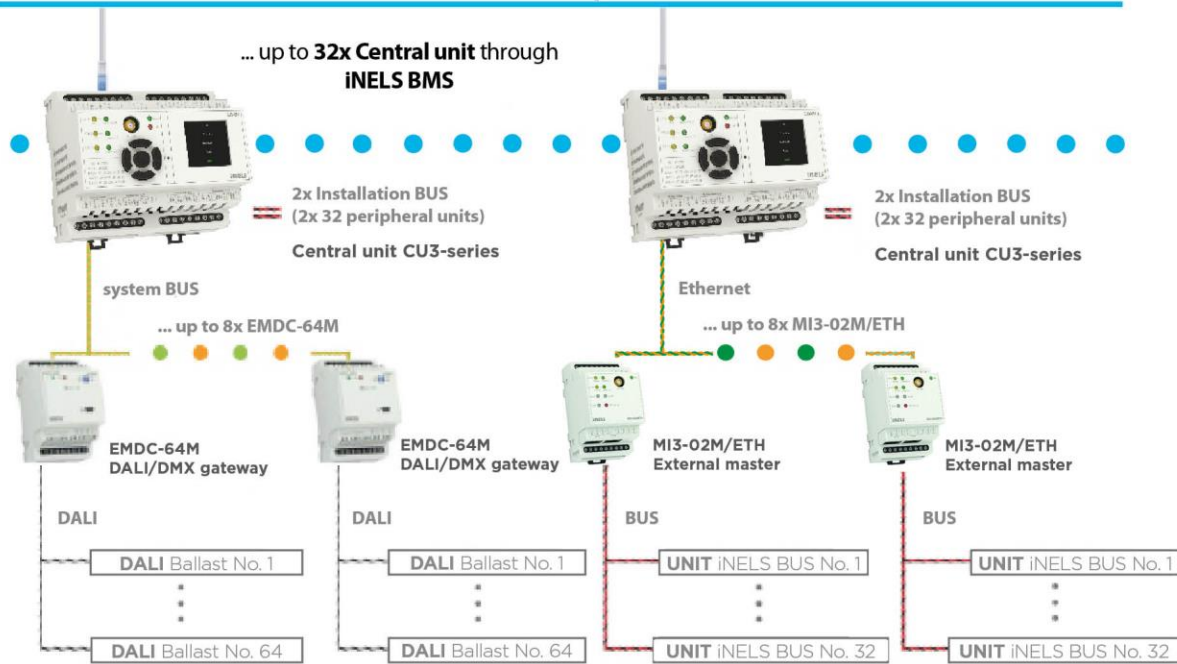

**AVAILABLE PROTOCOLS:**



...and more

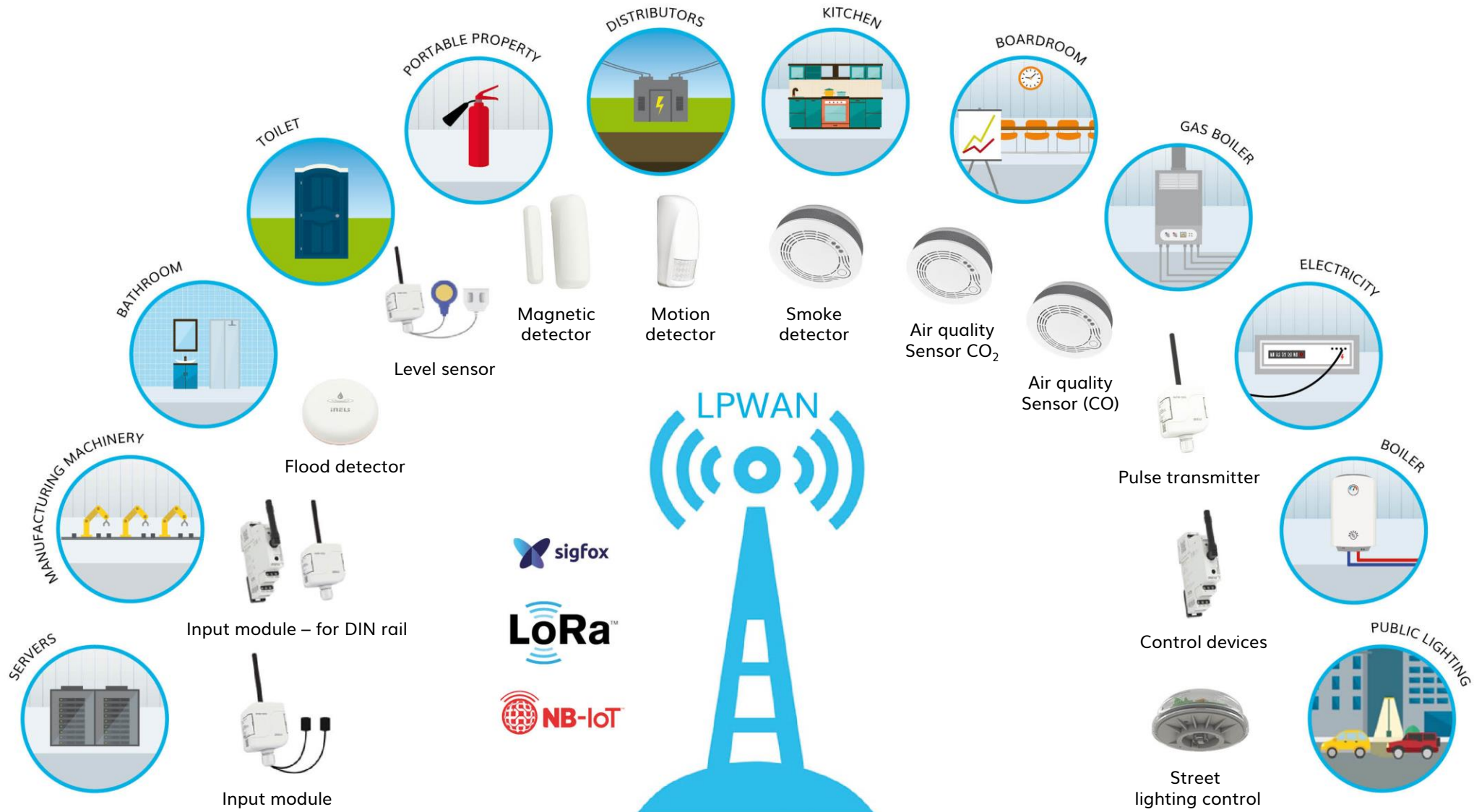



# OUR SOLUTIONS

# Smart Home – What can I control?

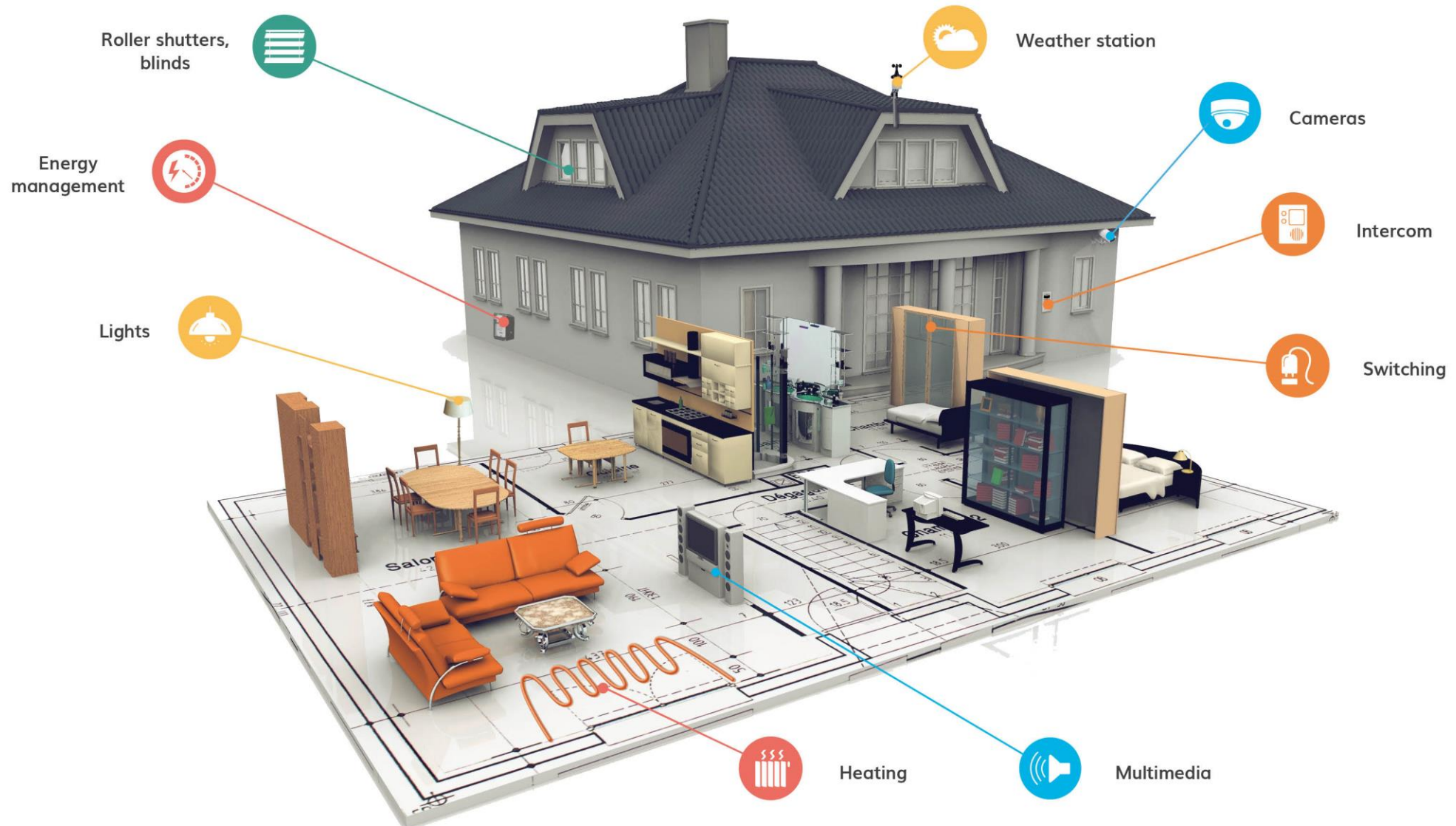

## Building Management System

- It is an integral part of any modern building
- It integrates the different technologies into the building into one unit
- Contemporary buildings focus on energy consumption, safety, quality and healthy work environment
- iNELS BMS is powered and Full compatible with Honeywell Niagara standards



## For new & existing hotel rooms

- iNELS smart system is ready to fulfil its function of security, clarity and comfort for the guest
- The card, chips or phone access system provides on-line access to the room
- Motion sensors can then be set directly to the home environment
- The clear glass panels at the bed or the central touch panels at the entrance can control everything the guest may want
- Interconnection at the reception and the hotel's service is a matter of course



Comfort



Savings



Design



Safety







Flexibility



## LARA multimedia unit is also well designed for hospitals that connects five great functions into one product

- Radio player you can simply play favourite radio stations
- Multimedia player to listen music from external sources
- Intercom for communicating between patient and nurse
- Videophone provides closer monitoring of patients
- Audiozone serves for controlling of multimedia in patients room
- SOS Emergency Button that you can place anywhere



-  SOS emergency button
-  SOS call
-  Radio & Music
-  Intercom
-  Room automatization





- Smart City is tomorrow's place
- It will be at the heart of the revolution and innovative solutions
- It does not offer only the products but also the technology that are the basis of every Smart City
- Smart buildings, urban furniture, air condition monitoring or weather monitoring and environmental aspects



Eliminating crime



Permanent surveillance



Property protection



Warning on time system



Call for immediate assistance

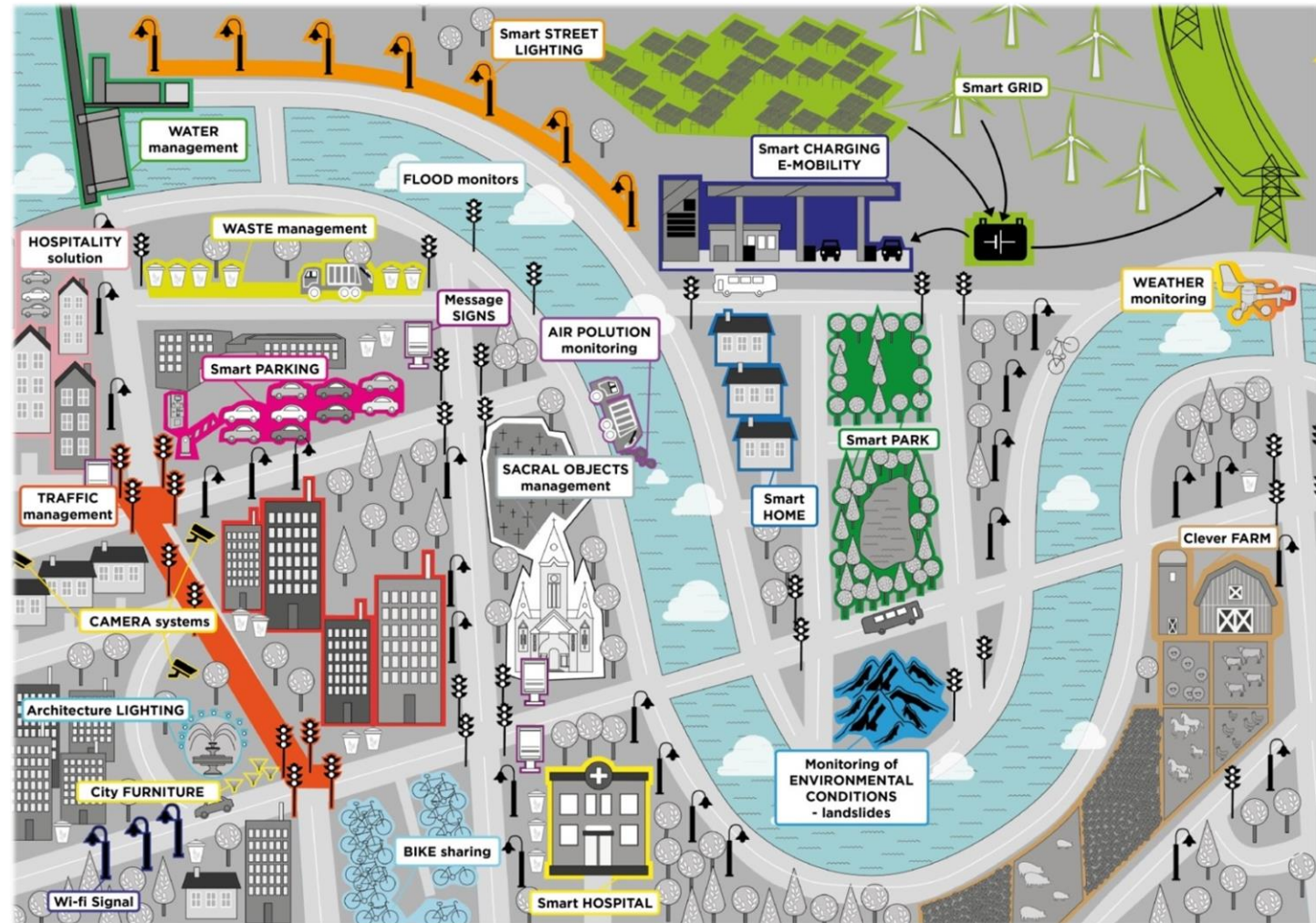

- The Smart Pole of iNELS is designed for regular street lighting in any „Street“ but in the „City“ its options make it an ideal technological oasis
- It also brings additional extensions: air quality monitoring, bicycle rechargers, SOS button, intercom, interactive touch panel
- All technologies are integrated into the Smart City Platform

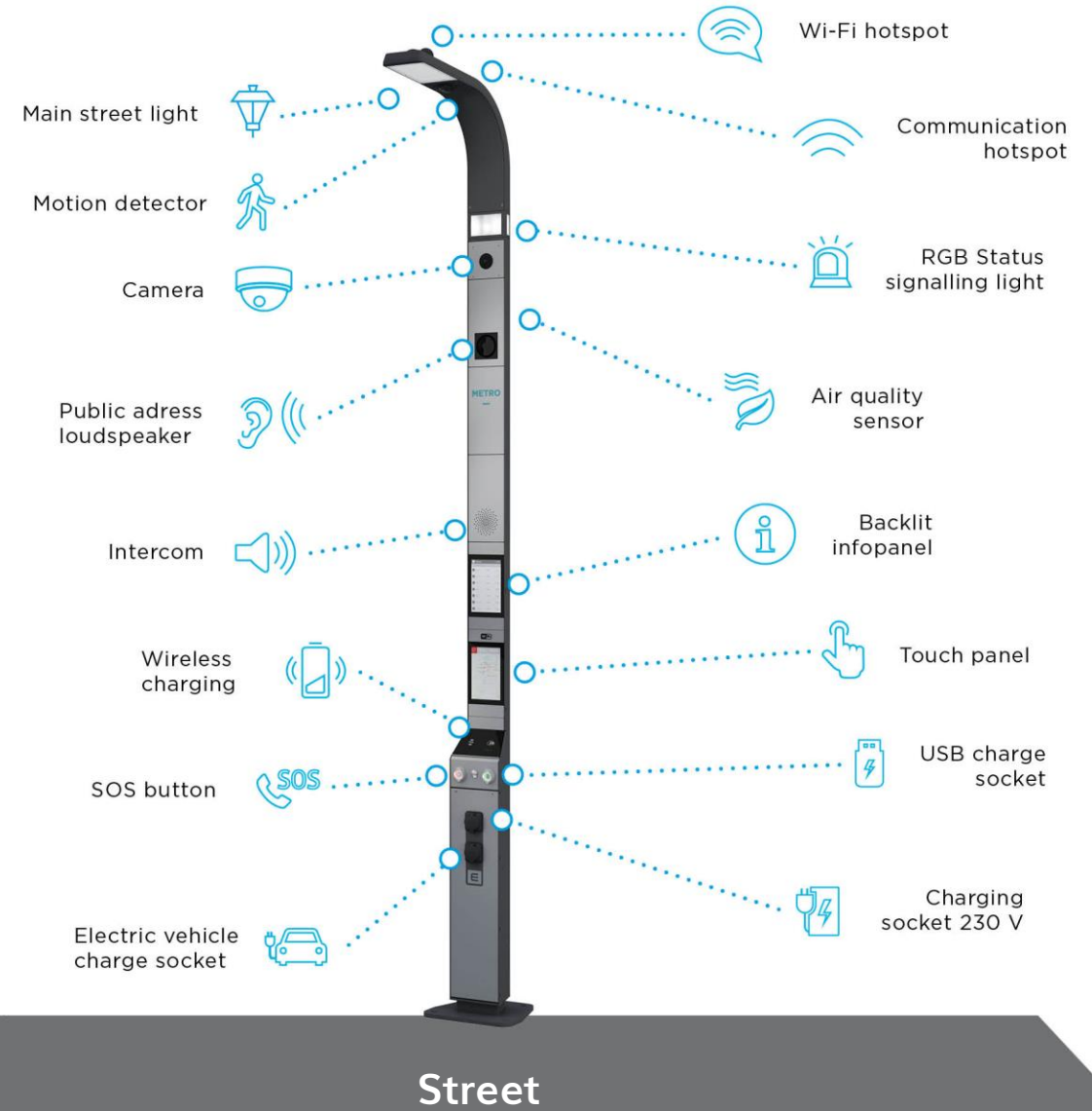

Charger

Kiosk

City

Street

People assets positioning (RTLS)

Secure access systems

Meeting room reservation

Energy management

Air quality monitoring

Audio / Video systems

Interactive blinds

Camera surveillance

Control lighting

Ventilation

Teleconferencing

Temperature control

BMS / integration

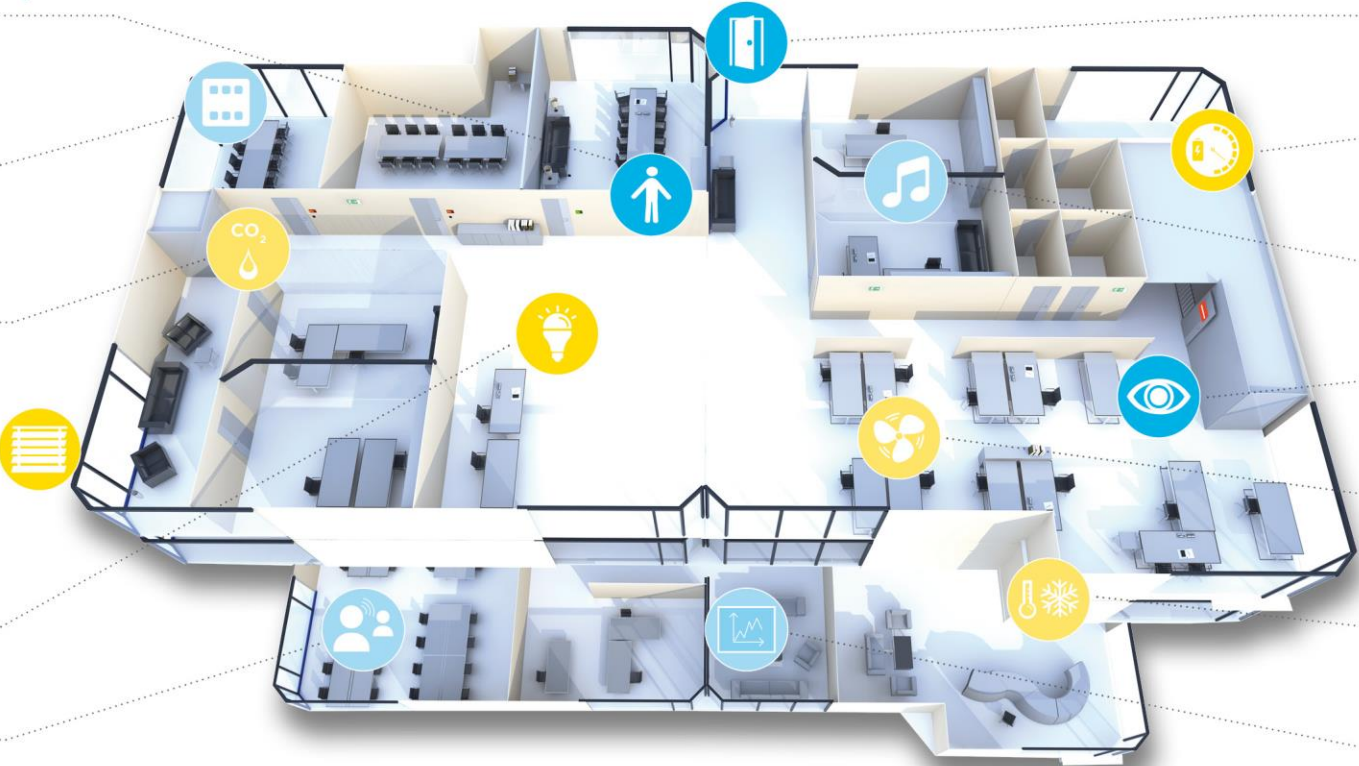

# iNELS sales policy – product flow



System partner



Customer

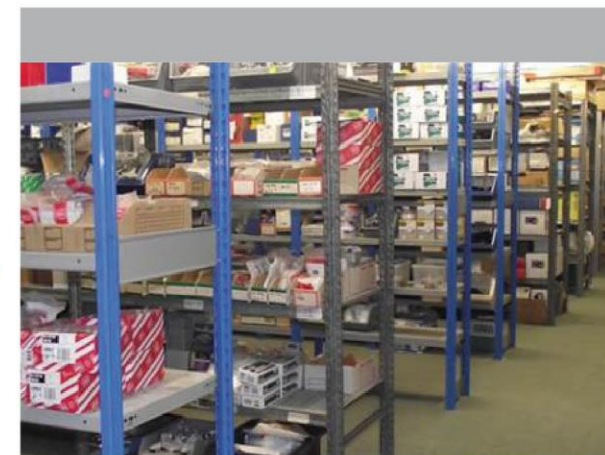

Wholesale / retail



# REFERENCES



## Prague Czech Republic

- Private cinema
- 10 dimmed, 35 switch lights
- Sauna, whirlpool

Realization: iNELS Czech Republic



## Controlling

- ✓ Appliances control
- ✓ Lighting / Dimming
- ✓ Appliances switching
- ✓ Shutters / Blinds
- ✓ HVAC
- ✓ Audio / Video

## Prague Czech Republic

- 6 dimmed, 25 switch lights
- Shutters, curtains
- Individual heating control

Realization: iNELS Czech Republic



## Controlling

- ✓ Appliances control
- ✓ Lighting / Dimming
- ✓ Appliances switching
- ✓ Shutters / Blinds
- ✓ HVAC
- ✓ GRMS





## Piņķi Latvia

- 2 floors, garage, sauna and 3 bedrooms
- 15 Dimmable Lighting zones, 8 wireless controllers, phone controlling functionality
- Lighting automation cycles to make lights automatically turn off in the holiday period. 10 scenes

Realization: ELKO EP Export



## Controlling

- ✓ Appliances control
- ✓ Lighting / Dimming
- ✓ Appliances switching
- ✓ Shutters / Blinds
- ✓ HVAC
- ✓ Audio / Video

## Vilnius Latvia

- Wood passive house
- Ventilation and shielding control
- Camera system

Realization: ELKO EP Export

## Controlling

- ✓ Appliances control
- ✓ Lighting / Dimming
- ✓ Appliances switching
- ✓ Shutters / Blinds
- ✓ HVAC
- ✓ GRMS
- ✓ Cameras

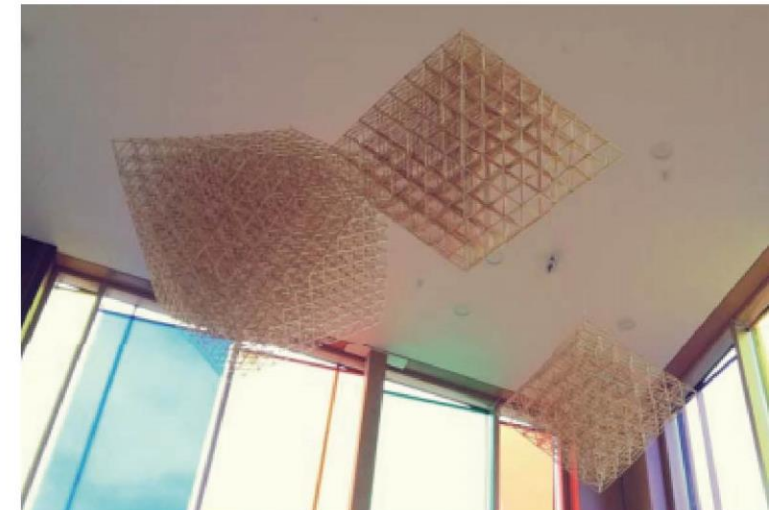



## Dubai UAE

- Garden irrigation
- Home appliance integration
- Intercom and LARA

Realization: ELKO EP Middle East



## Controlling

- ✓ Appliances control
- ✓ Lighting / Dimming
- ✓ Appliances switching
- ✓ Shutters / Blinds
- ✓ HVAC
- ✓ Cameras
- ✓ Intercom
- ✓ Audio / Video
- ✓ Irrigation

## Amman Jordan

- 24 rooms
- HVAC complex control
- LARA, Intercom, Video door phone
- Garden irrigation control

Realization: ELKO EP Export



## Controlling

- ✓ Appliances control
- ✓ Lighting / Dimming
- ✓ Appliances switching
- ✓ Shutters / Blinds
- ✓ HVAC
- ✓ Audio / Video
- ✓ Irrigation







## Kyrenia Cyprus

- 125 rooms
- Complete management of hotel rooms
- Scenes: arrival/departure and day/night
- GRMS

Realization: ELKO EP Export

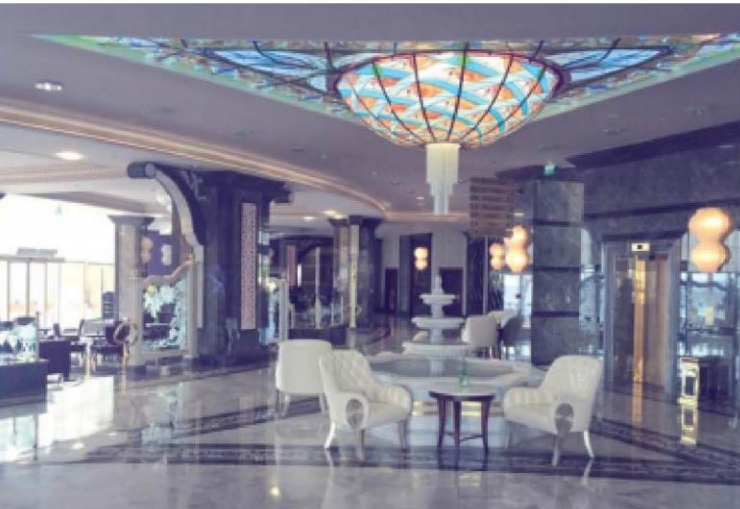

## Controlling

- ✓ Appliances control
- ✓ Lighting
- ✓ Shutters / Blinds
- ✓ GRMS
- ✓ Access control system
- ✓ Audio / Video

## Kyrenia Cyprus

- 5-star hotel
- Located close to historical city Kyrenia
- The lights are controlled in iNELS system via light panel, USB socket, glass thermostats

Realization: ELKO EP Export

## Controlling

- ✓ Appliances control
- ✓ Lighting
- ✓ DALI integration
- ✓ Audio / Video





## Nicosia Cyprus

- Operation of atmosphere lights
- Lighting scenes
- Promo Video zones

Realization: ELKO EP Export



### Controlling

- ✓ Appliances control
- ✓ Lighting / Dimming

## Budapest Hungary

- iNELS BUS System is controlling lighting and terrace-cooling/heating
- High voltage neon signs and lighting control

Realization: ELKO EP Hungary

### Controlling

- ✓ Appliances control
- ✓ Lighting / Dimming
- ✓ Automatic scenes
- ✓ HVAC
- ✓ Energy management





## Budapest Hungary

- Jewelry in the heart of Budapest
- Unique jewelry & Forever Mark diamonds

Realization: ELKO EP Hungary



### Controlling

- ✓ Appliances control
- ✓ Lighting / Dimming
- ✓ DALI integration or DMX integr.
- ✓ HVAC
- ✓ Monitoring center

## Amman Jordan

- Over 100 offices
- Access and attendance system
- Shading according to sunshine
- A/C OFF when window open

Realization: ELKO EP Export



### Controlling

- ✓ Appliances control
- ✓ Lighting / Dimming
- ✓ Automatic scenes
- ✓ HVAC
- ✓ Energy management
- ✓ Blinds





## Budapest Hungary

- 6 movie theaters
- DALI control LED matrix (800 lighting fixtures)
- Projection scenes
- Heating and A/C control

Realization: ELKO EP Hungary



## Controlling

- ✓ Appliances control
- ✓ Lighting / Dimming
- ✓ DALI integration or DMX integr.
- ✓ HVAC
- ✓ GRMS
- ✓ BMS integration
- ✓ Audio / Video

## Budapest Hungary

- Every additional lighting source is also controlled by iNELS system
- The devices here are controlled by RF Touch
- For switching the RFSA-11B and RFSA-66M is used

Realization: ELKO EP Hungary



## Controlling

- ✓ Appliances control
- ✓ Lighting / Dimming
- ✓ DALI integration or DMX integr.
- ✓ HVAC
- ✓ Monitoring center



## Petrovice Czech Republic

- 47 dimming, 63 switching circuits
- Management of 30 m of RGB strips
- Control, ceramic loungers, SPA and swimming pools

Realization: iNELS Czech Republic



## Controlling

- ✓ Appliances control
- ✓ Lighting / Dimming
- ✓ DALI integration or DMX integr.
- ✓ HVAC
- ✓ Monitoring center

## Prague Czech Republic

- Comfortable control of the fitness and wellness centre
- Supervision of the operation of saunas and whirlpools

Realization: iNELS Czech Republic

## Controlling

- ✓ Appliances control
- ✓ Lighting / Dimming
- ✓ Shutters / Blinds
- ✓ HVAC
- ✓ Monitoring center





## Husinec Czech Republic

- Reconstructed in 2015, now - museum and exhibition
- Exhibit lighting control, scenes
- Control from touch panels

Realization: iNELS Czech Republic



### Controlling

- ✓ Appliances control
- ✓ Lighting / Dimming
- ✓ Automatic scenes
- ✓ HVAC
- ✓ GRMS
- ✓ Monitoring center
- ✓ Energy management
- ✓ Access control

## Thimphu Bhutan

- Lighting control of historical interior sections
- Scenes light according to visitor presence
- Security system

Realization: ELKO EP Export



### Controlling

- ✓ Appliances control
- ✓ Lighting / Dimming
- ✓ DALI integration or DMX integr.
- ✓ Automatic scenes
- ✓ HVAC
- ✓ GRMS





## Nošovice Czech Republic

- 736 pcs LED High Bay within retrofitted lighting
- Central control DALI ballast via EDMC
- Control of each zone from the touch panel via app

Realization: iNELS Czech Republic

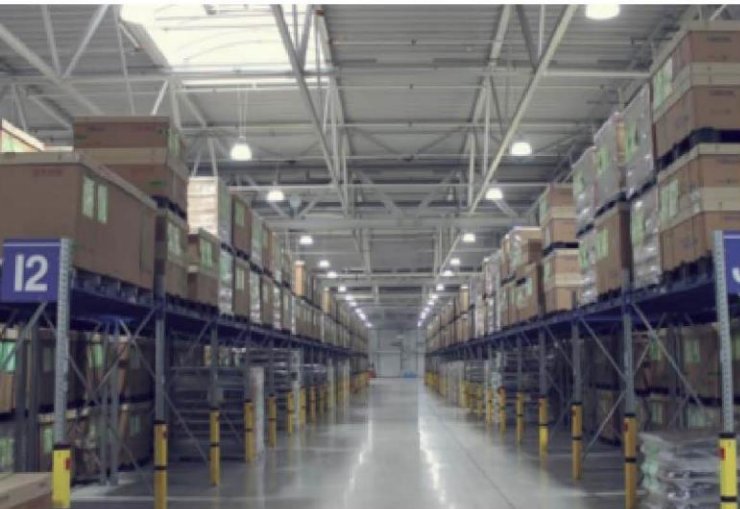

## Controlling

- ✓ Appliances control
- ✓ Lighting / Dimming
- ✓ DALI integration or DMX integr.
- ✓ Automatic scenes
- ✓ Monitoring center
- ✓ Energy management

## Brno Czech Republic

- 14 showrooms, 40 offices
- 200 dimming lights circuits
- DALI control of 45 circuits in the training room
- iNELS Multimedia

Realization: iNELS Czech Republic



## Controlling

- ✓ Appliances control
- ✓ Lighting / Dimming
- ✓ DALI integration or DMX integr.
- ✓ Automatic scenes
- ✓ HVAC
- ✓ GRMS
- ✓ Monitoring center
- ✓ Energy management
- ✓ Audio / Video
- ✓ Blinds
- ✓ Access control





## Moscow Russia

- LED tray lighting control according to the outside twilight
- Fire system
- Security: detectors, cameras

Realization: ELKO EP Russia



## Controlling

- ✓ Appliances control
- ✓ Lighting / Dimming
- ✓ DALI integration or DMX integr.
- ✓ Automatic scenes
- ✓ HVAC
- ✓ GRMS
- ✓ Monitoring center
- ✓ Access control

## Dubai UAE

- Lighting control in cooperation with Preciosa Lighting

Realization: ELKO EP Middle East



## Controlling

- ✓ Appliances control
- ✓ Lighting / Dimming
- ✓ DALI integration or DMX integr.
- ✓ Automatic scenes
- ✓ HVAC
- ✓ GRMS

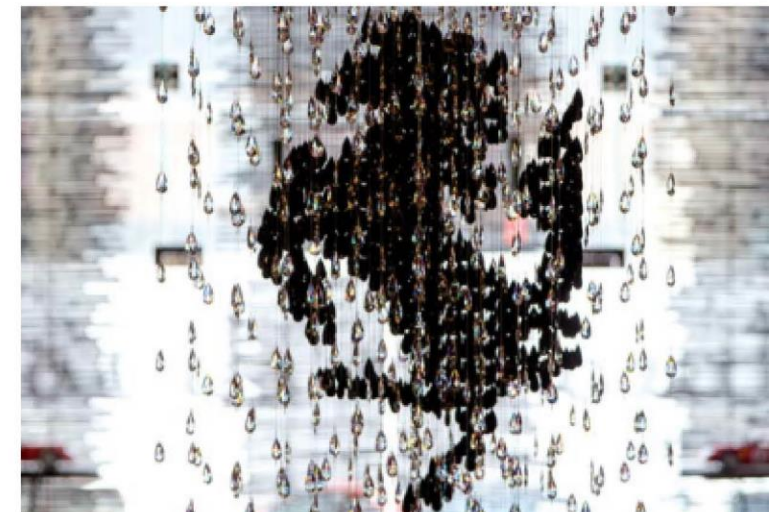



# Smart Street Lighting



Hranice (Czech Republic)



BEFORE

AFTER



2000 K

brightness control

X

chromacity temperature

14 892 kWh

power consumption

170 W

output

4 000 K

chromacity temperature

0-100 %

brightness control

4 327 kWh

power consumption

59 W

output

# Smart Street Lighting



Holešov

**Location:** Holešov, Czech Republic

**Place of the instalation:** ELKO EP Holding





# OUR SUPPORT

# iNELS Academy - Regularly Trainings



EDUCATE YOURSELF **ON-LINE**  
FROM THE COMFORT OF YOUR COUCH!  
**WEBINARS**

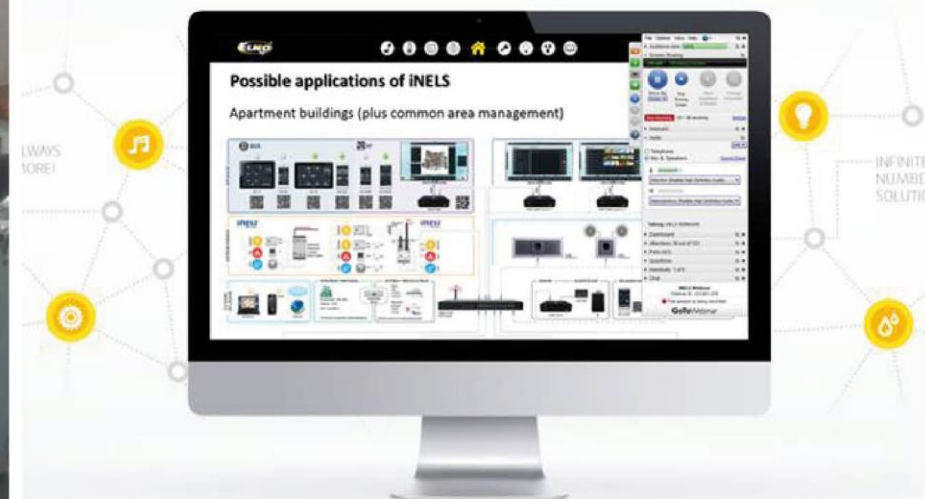

All you need is an internet-accessible computer  
and willing to educate!

More information on [www.elkoep.com/trainings-and-exhibitions](http://www.elkoep.com/trainings-and-exhibitions)

Consultant



Design



Realization support on site



# Customization

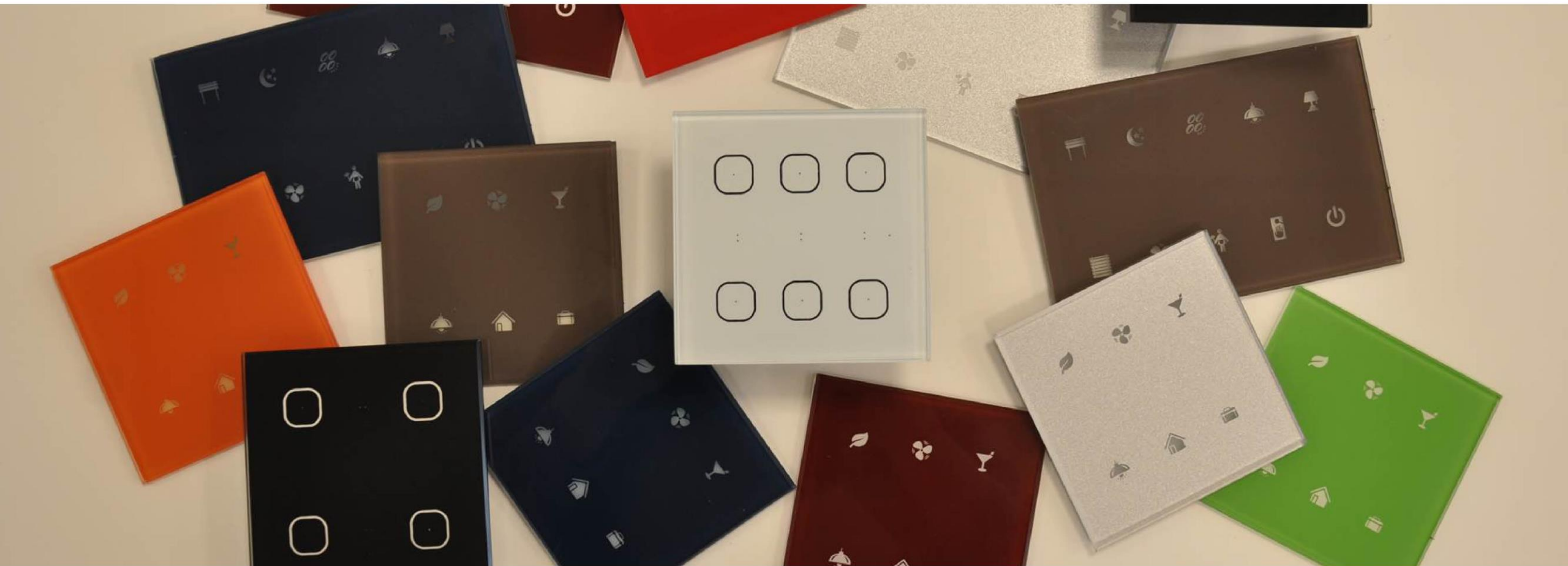

# Brand labeling



DETECTORS



Smoke



Motion



Window/door

BULBS



RGB/LED

CONECTORS



Dimmer

CUSTOM DESIGN

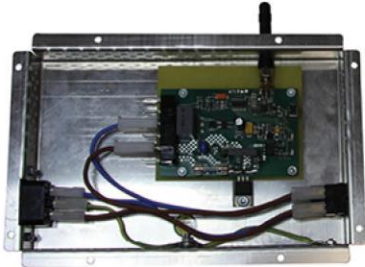

RF PWM unit



# Apps as you like



**INELS**



**CLICK**  
ScolmoreGROUP



**P**  
Paulmann







SAMSUNG  
**Gear S2 | Gear S3**



# Technical & Online Support



**Support ELKO EP**   

 **Live chat**  
We are online

**Support ELKO EP:**  
Hello, how can I help you?

**Visitor:**  
Hello, I have an interested about your product LARA Radio. What components I need for complete set? Do you have frame in other colors?



**Support ELKO EP:**  
Thank you for your interest. You need a LARA Radio, reproducers, a frame, kabela and PoE adapter. We have frames in more colors. Can I recommend this configurator, where you choose, what LARA do you want?

**Visitor:**  
Yes, of course, send me.

**Support ELKO EP:**  
There is link: <http://lara.inels.cz/>. Can I help you with other question?

**Visitor:**  
No, thank you very much. Have a nice day.

**Support ELKO EP:**  
Have a nice day too.

Powered by  

Customer service

24  
hour

Support per week

7  
days

Tips / Advice / Help

12  
months

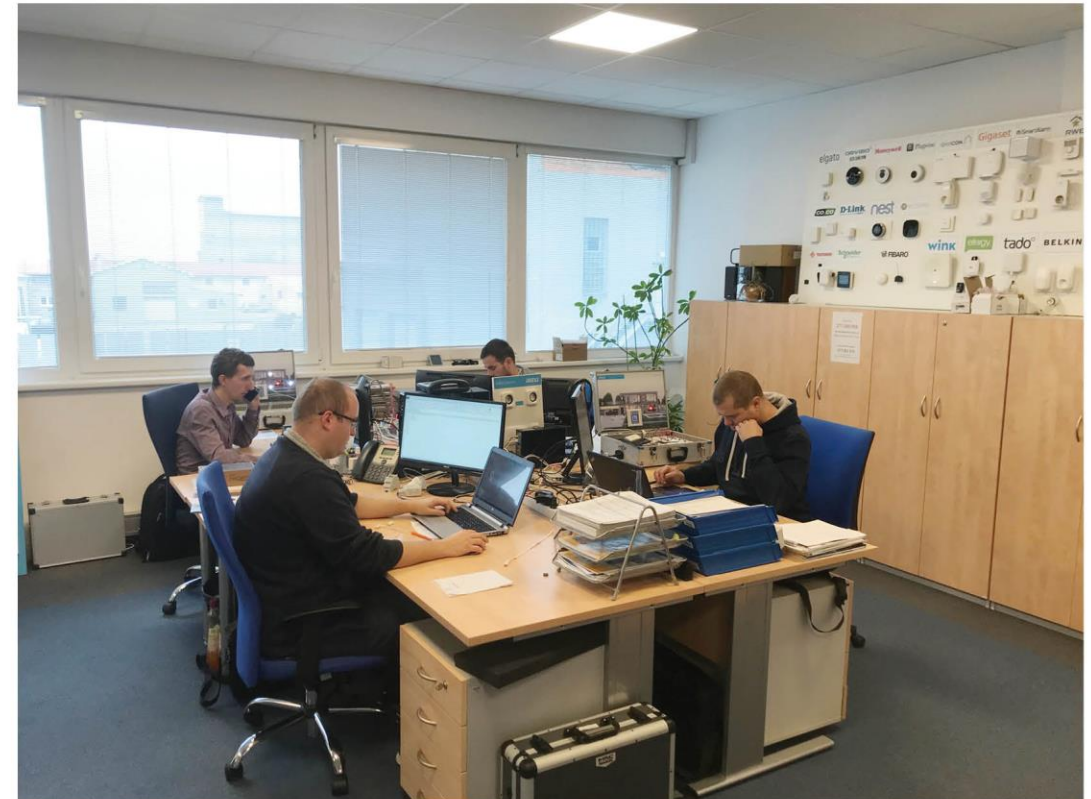

# Customer's Questions in Ticket system



osTicket Support Center Ticket Tracking

Welcome back, **Kapitanov** | [Admin Panel](#) | [My Preference](#) | [Log Out](#)

Tickets Knowledge Base Directory My Account FAQs

Open (8) My Tickets (1) Closed Tickets New Ticket

Query:   [Advanced]

Showing 1 - 8 of 8 Open Tickets

Ticket	Date	Subject	Department	Priority	From
<input type="checkbox"/> 972735	30/11/2016	Re: Re: Re: 150W UFO LED High bays—35\$	Support	Normal	Indiamps
<input type="checkbox"/> 925370	29/11/2016	Nedoručenie: Support Ticket Opened ...	Support	Normal	Microsoft Outlook
<input type="checkbox"/> 885497	29/11/2016	Nezise dokončit upgrade FW EST-3	Support	Normal	Antonin Podzemny
<input type="checkbox"/> 743092	28/11/2016	Inels RF - ovládní přes internet	Support	Normal	Radek Kluka
<input type="checkbox"/> 635516	23/11/2016	NB-iot	Support	Normal	Daniel Arlica
<input type="checkbox"/> 661750	24/09/2016	Smart column	INELS	Normal	Motaseem Khalil
<input type="checkbox"/> 223424	12/07/2016	dotaz na LoRa Gateway	Support	Normal	Pavel Chaloupka
<input type="checkbox"/> 992787	04/05/2016	VIS-428-40230V	Relay	Normal	Radek Hartman

Select: All None  page: [1]

Copyright © 2006-2016 osTicket.com. All Rights Reserved.

osTicket Support Center Ticket Tracking

Welcome back, **Kapitanov** | [Admin Panel](#) | [My Preference](#) | [Log Out](#)

Tickets Knowledge Base Directory My Account FAQs

Premade Replies New Premade Reply

**Edit Premade Reply**

Title:

Status:  Active  Offline

Category: Department under which the 'answer' will be made available.

Answer:   
osTicket is a widely-used open source support ticket system, an attractive alternative to higher-cost and complex customer support systems - simple, lightweight, reliable, open source, web-based and easy to setup and use.

Copyright © 2006-2016 osTicket.com. All Rights Reserved.

# Partners Section

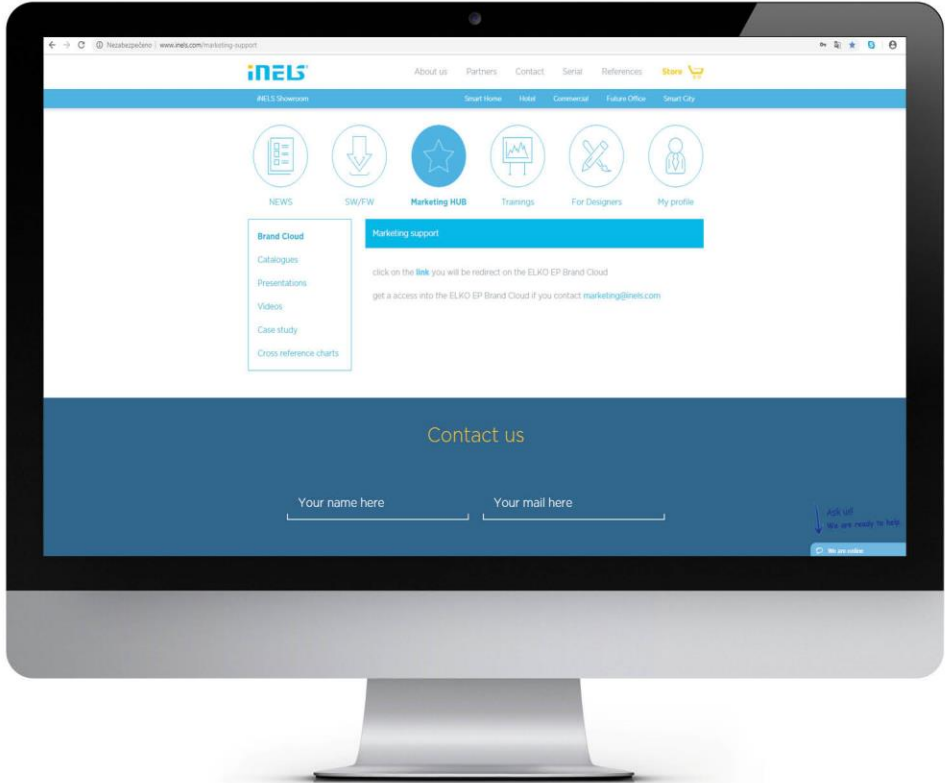

## Case study

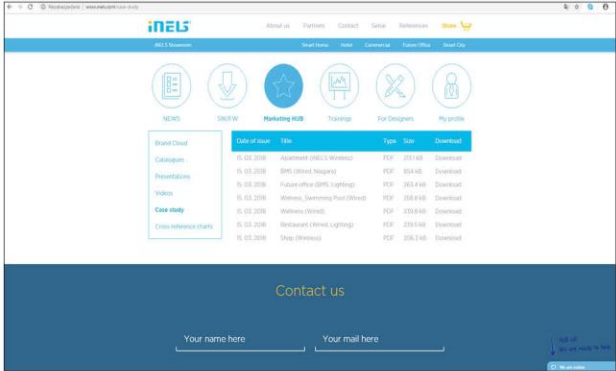

## Cross reference charts

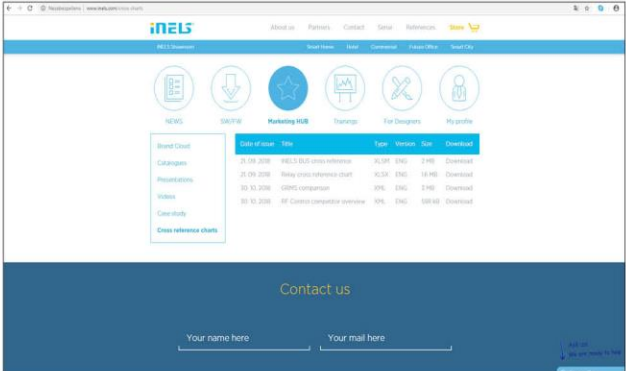

## News

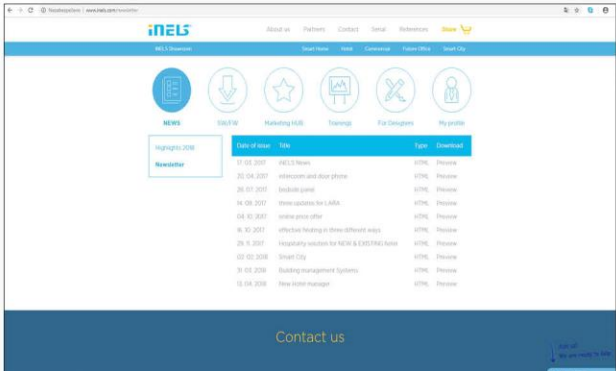

## Presentations

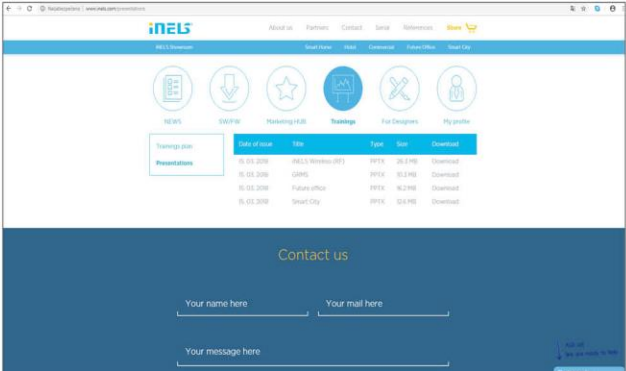

## BrandCloud

- Central storage of all marketing's and other support's materials
- Logos, logo manuals, advertisements, banners, prints, products photos, photos from exhibitions and other events ...
- Ask for access

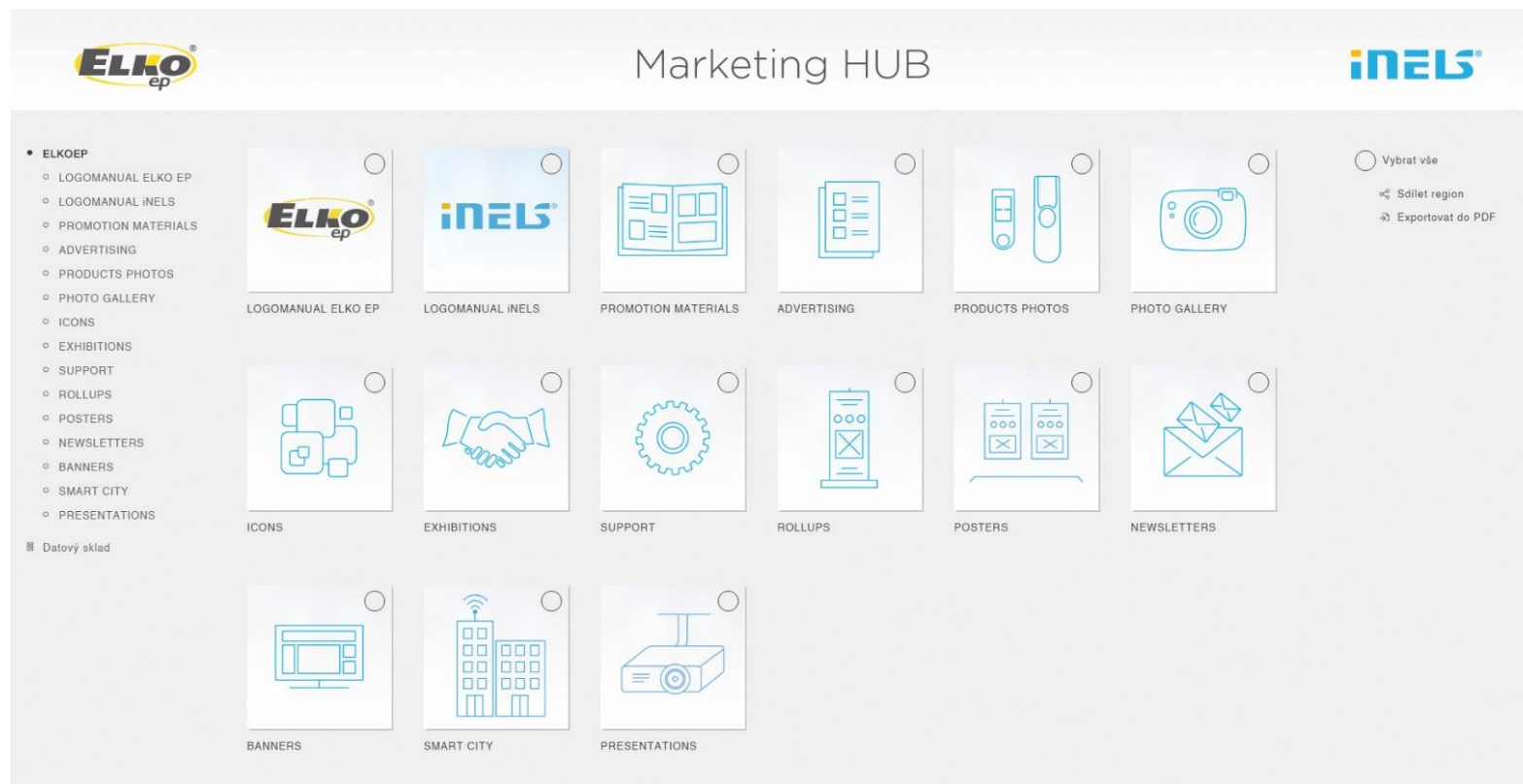

# Free & Open API



**API** – command description for free

**ASCII** - communication with 3rd parties directly from CU3s iNELS

**XMLRPC** – communication between ConnectionServer and applications

**ElkoNET** – communication between ConnectionServer and CU3s iNELS

**Promotic** – Scada vizualization

**Niagara** – BMS systems, PMS systems, Dashboards



# Cloud

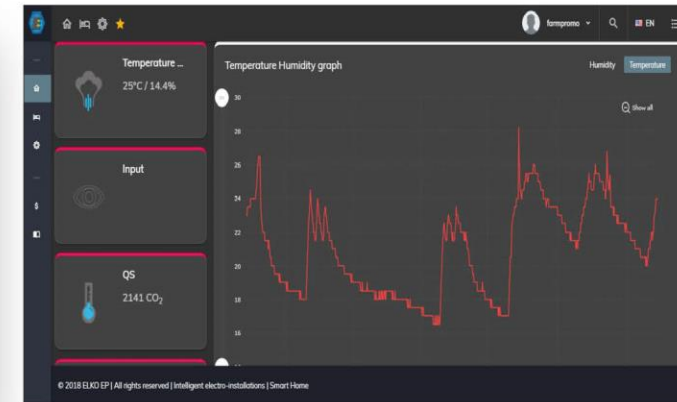
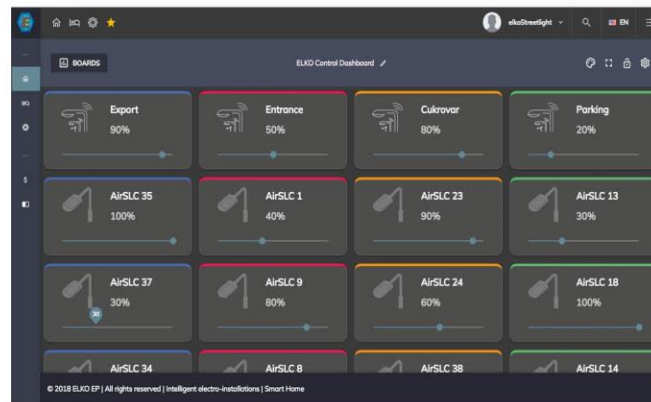
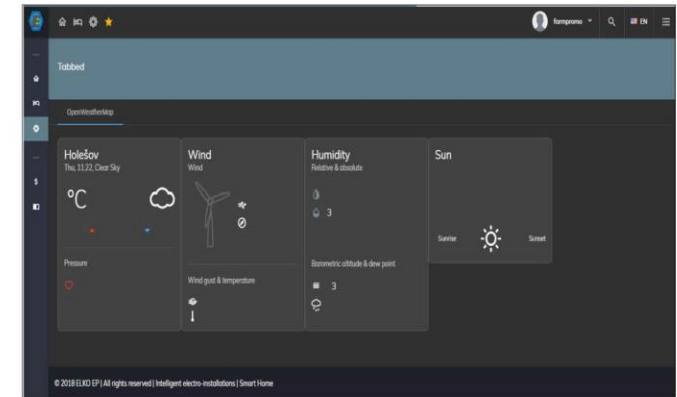
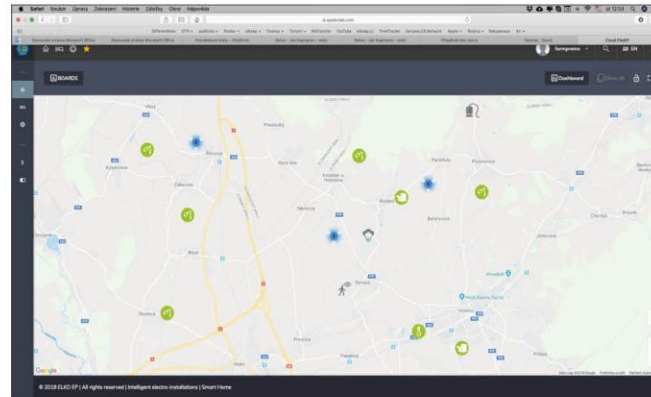
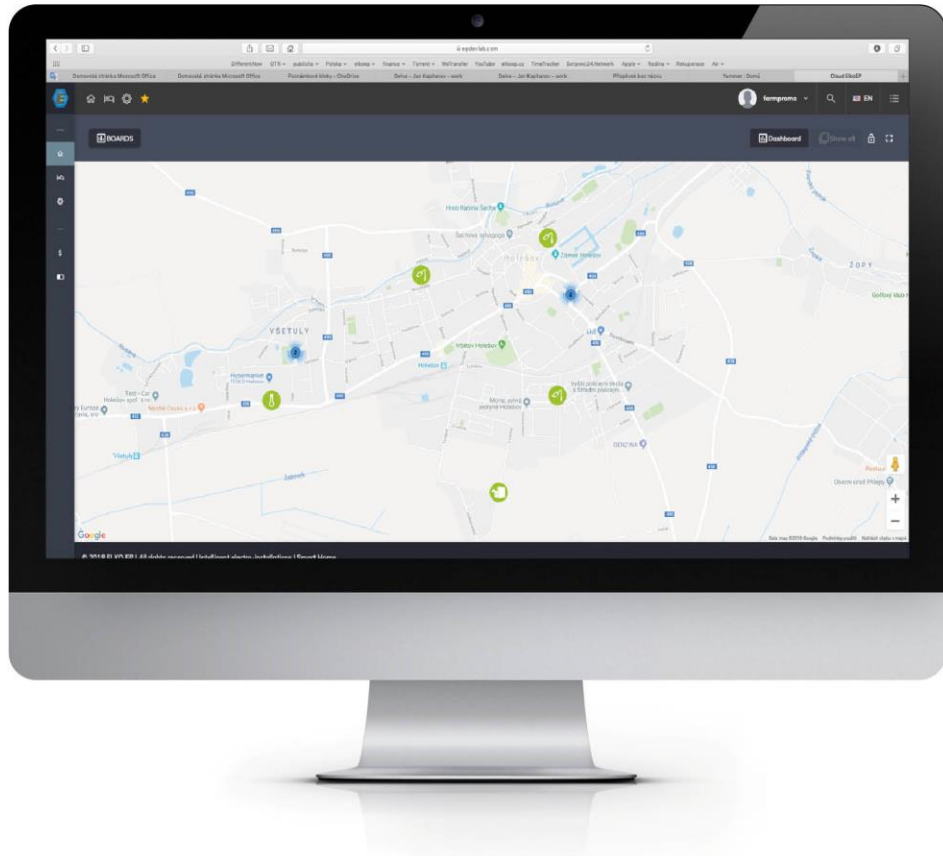

# Well fit stock



**WAREHOUSE  
VALUE**  
**445.000**  
EUR

Next day shipment  
Flexibility deliver on projects





With on-line access to production system

The screenshot displays the ELKO EP B2B portal interface. At the top, there is a search bar with the text "Hledaný text" and a magnifying glass icon, a "Contact" link, a shopping cart icon showing "(0 / 0.00 CZK)", and a "Registration enter" link with a user icon. Below the search bar, there is a navigation menu with "800 100 671 - ONLINE" and "RF Control > Wireless control / system components". A left sidebar contains a list of categories: "RELAY > Electronic Devices", "RF Control > Wireless control" (highlighted), "drivers", "system components", "RF Touch", "Switches", "dimmers", "Lighting", "temperature regulation", "monitoring elements", "RF Sets", "Application", "Accessories", "SMART SET", "Energy Measurement", and "AUDIO / VIDEO". A pop-up window titled "B2B ELKO EP" is overlaid on the product listings, displaying availability information: "50 ks availability: immediately", "96 ks availability: 18.11.2016", and "378 ks availability: on request". The main product grid shows three items: "eLAN-RF-003 Smart RF box" (4110 CZK stock), "eLAN-RF-wireless 003\_2,4GHz Smart RF box with WiFi" (5140 CZK stock), and "RFGSM-220M Multifunction GSM communicator" (5140 CZK stock). Below these are three "RF Touch-B" touch control units, with the third one, "RF Touch-B\_červená / Touch control unit, in-wall", highlighted with a red border.





# MARKETING SUPPORT

# Meet us in exhibitions

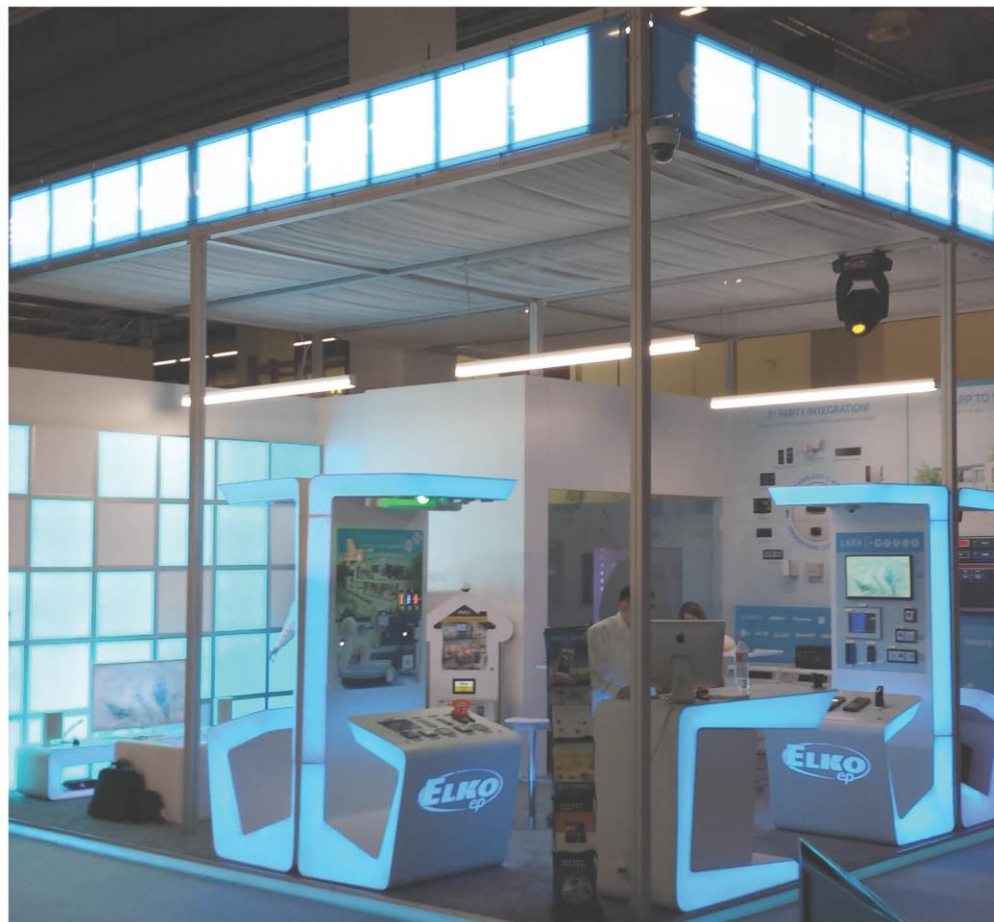
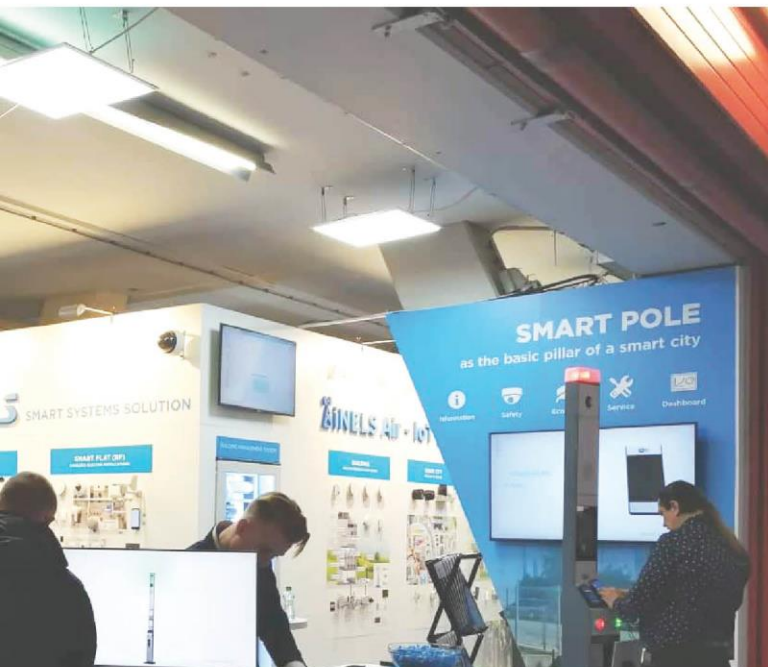

- 25 fairs and exhibitions
- 10 conferences per year

## LARA

**INELS** smart home solutions

**ELKO ep**

### PRICE OFFER

Your requirements for modern electro-installation:

Are you interested in our intelligent electro-installation? Or would you like to receive an offer that suits your housing project perfectly? So then please fill this form and send us back to our email [support@elko.com](mailto:support@elko.com). Please fill your contact details at the bottom of the form. If any further information is needed we can easily contact you via mail. The first price calculation will be sent to you via mail.

**Lighting**

Lighting	The number of lighting points in each room which you need to install (input)	Garage	Entrance	Hall	Staircase	Kitchen	Dining room	Bedrooms	Living room	Children's bedroom 1	Children's bedroom 2	Children's bedroom 3	Guest room	Workroom	Bedroom 1	Bedroom 2	Toilet 1	Toilet 2	Pantry	Laundry room	Bath or room	Utility room	Store room	Please specify other rooms	
<b>incandescent</b>	The number of lighting points in each room which you need to install (input)																								
<b>energy saving</b>																									
<b>LED</b>																									
<b>LED strip white</b>																									
<b>LED strip color</b>																									

**Switches**

Switches	The number in each room	Garage	Entrance	Hall	Staircase	Kitchen	Dining room	Bedrooms	Living room	Children's bedroom 1	Children's bedroom 2	Children's bedroom 3	Guest room	Workroom	Bedroom 1	Bedroom 2	Toilet 1	Toilet 2	Pantry	Laundry room	Bath or room	Utility room	Store room	Please specify other rooms	
<b>normal</b>	The number in each room																								
<b>switched</b>																									
<b>TV socket</b>																									
<b>data socket</b>																									

**Sockets**

Sockets	The number in each room	Garage	Entrance	Hall	Staircase	Kitchen	Dining room	Bedrooms	Living room	Children's bedroom 1	Children's bedroom 2	Children's bedroom 3	Guest room	Workroom	Bedroom 1	Bedroom 2	Toilet 1	Toilet 2	Pantry	Laundry room	Bath or room	Utility room	Store room	Please specify other rooms	
<b>normal</b>	The number in each room																								
<b>switched</b>																									
<b>TV socket</b>																									
<b>data socket</b>																									

**WE BRING YOU A COMPLEX PRICE CALCULATION AT YOUR FINGERTIPS**

Check list for your Price offer and calculation



## 1. Installation type

**Existing or new electrical installation?**

**I will build**  **I will reconstruct**

Are you going to build a house and thinking about the wiring? Choose this option.

If you thinking about the renovation of a house, apartment, hotel room or even a commercial building, select this option.

**The degree of damage to the building**

**I can cut into the wall**  **I can't cut into the wall**

If you building a new house, or doing extensive renovations, which includes completely new wiring, select this option.

If you do not intend to install completely new wiring for electrical installations, but you want to revitalize your existing housing, select this option.

## 2. Object

**My object is**

**Flat**

Object size:

**House**

Object size:

**Hotel**

Object size:

**Commercial building**

Object size:

## 3. What to control

**Temperature control**

Radiators  
 Water underfloor  
 EL underfloor  
 Fancoil

**Ventilation**

Recuperation  
 Air conditioning  
 Ventilation

**Detectors**

Motion  
 Smoke  
 Doors/windows

**Multimedia**

Audio  
 Video

**Measuring energy**

Electricity  
 Water  
 Gas

**Monitoring**

Weather station  
 Cameras  
 Flood  
 Monitoring voltage

**Lighting control**

ON/OFF + timing  
 ON/OFF + dimming  
 LED strip

**Shading**

Shutters  
 Curtains  
 Awning

**Other**

Miele appliances  
 Sockets

## 4. How to control

	Remote RF controller with display	4 buttons remote key chain	Wireless wall controller	Wireless nightlight switch	Control touch panel	Wall glass touch controller	Wall controller	Digital room climate regulator	Smart phone or tablet	PC or notebook	Smart TV
EL underfloor					<input checked="" type="checkbox"/>			<input checked="" type="checkbox"/>	<input checked="" type="checkbox"/>	<input checked="" type="checkbox"/>	<input checked="" type="checkbox"/>
Fancoil					<input checked="" type="checkbox"/>			<input checked="" type="checkbox"/>	<input checked="" type="checkbox"/>	<input checked="" type="checkbox"/>	<input checked="" type="checkbox"/>
Recuperation					<input checked="" type="checkbox"/>			<input checked="" type="checkbox"/>	<input checked="" type="checkbox"/>	<input checked="" type="checkbox"/>	<input checked="" type="checkbox"/>
Air conditioning					<input checked="" type="checkbox"/>			<input checked="" type="checkbox"/>	<input checked="" type="checkbox"/>	<input checked="" type="checkbox"/>	<input checked="" type="checkbox"/>
Video									<input type="checkbox"/>	<input type="checkbox"/>	<input type="checkbox"/>
Cameras									<input checked="" type="checkbox"/>	<input checked="" type="checkbox"/>	<input checked="" type="checkbox"/>
Shutters	<input type="checkbox"/>	<input checked="" type="checkbox"/>	<input type="checkbox"/>	<input type="checkbox"/>	<input checked="" type="checkbox"/>	<input checked="" type="checkbox"/>	<input checked="" type="checkbox"/>	<input checked="" type="checkbox"/>	<input checked="" type="checkbox"/>	<input checked="" type="checkbox"/>	<input checked="" type="checkbox"/>

## 5. Summary

**Summary**

Common system units: 1884,20 €

Temperature control: 691,60 €

Fancoil: 327,00 €

Ventilation: 137,08 €

Air conditioning: 137,08 €

Multimedia: 0,00 €

Video: 0,00 €

Monitoring: 94,40 €

Cameras: 94,40 €

Shading: 700,50 €

**Total price: 3 971,86 €**

This price offer is only approximate, we will determine the exact price based on the individual requirements and the way of connection.

Start again  Save report

Add another device  Send an order

# General catalogues



Wireless electro-installation  
Smart home & building solutions



www.inels.com



Wireless (RF)  
electro-installations

Wired electro-installations  
Smart home & building solutions



www.inels.hu



Wired (BUS)  
electro-installations

Hospitality Solution  
for new & existing hotel rooms

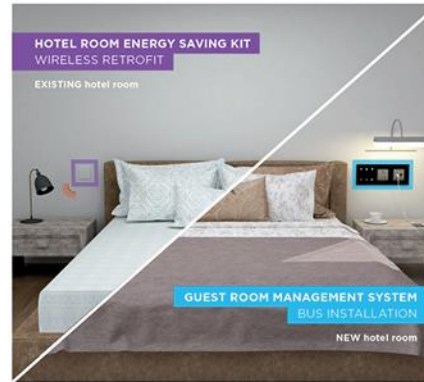

www.inels.com



Hospitality  
solutions

Lighting control  
Modern project solutions for houses and buildings



www.inels.com



Lighting  
control

iNELS Air  
Sensors and detectors for IoT



www.inels.com



iNELS Air

# Technical catalogues



Smart wireless  
electro-installation

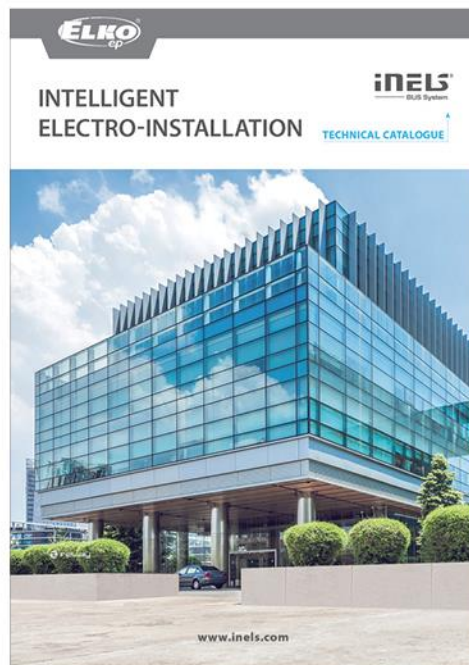

Intelligent  
Electro-installation

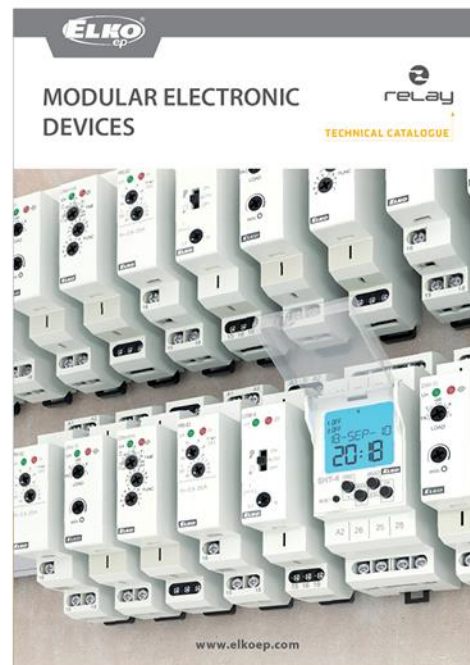

Modular  
electronic devices



Home switches  
and sockets



Product  
overview

Choose from „Live presentation“ [Click HERE](#)

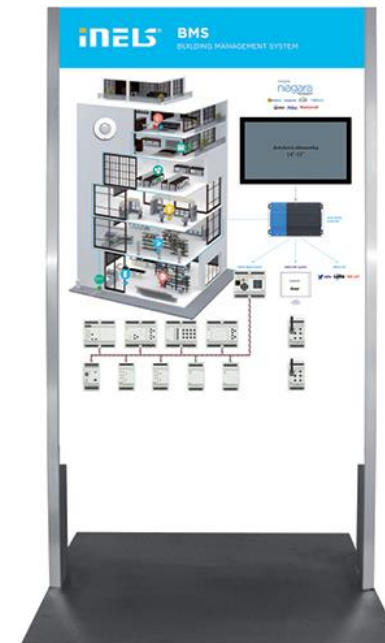



## iNELS BUS



## iNELS RF



## iNELS BUS (GRMS)

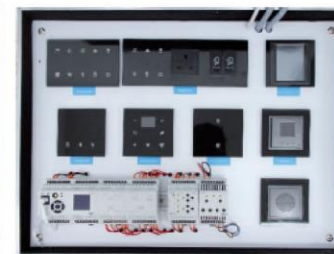

# Suitcases for your training



## BUS & Wireless & Multimedia

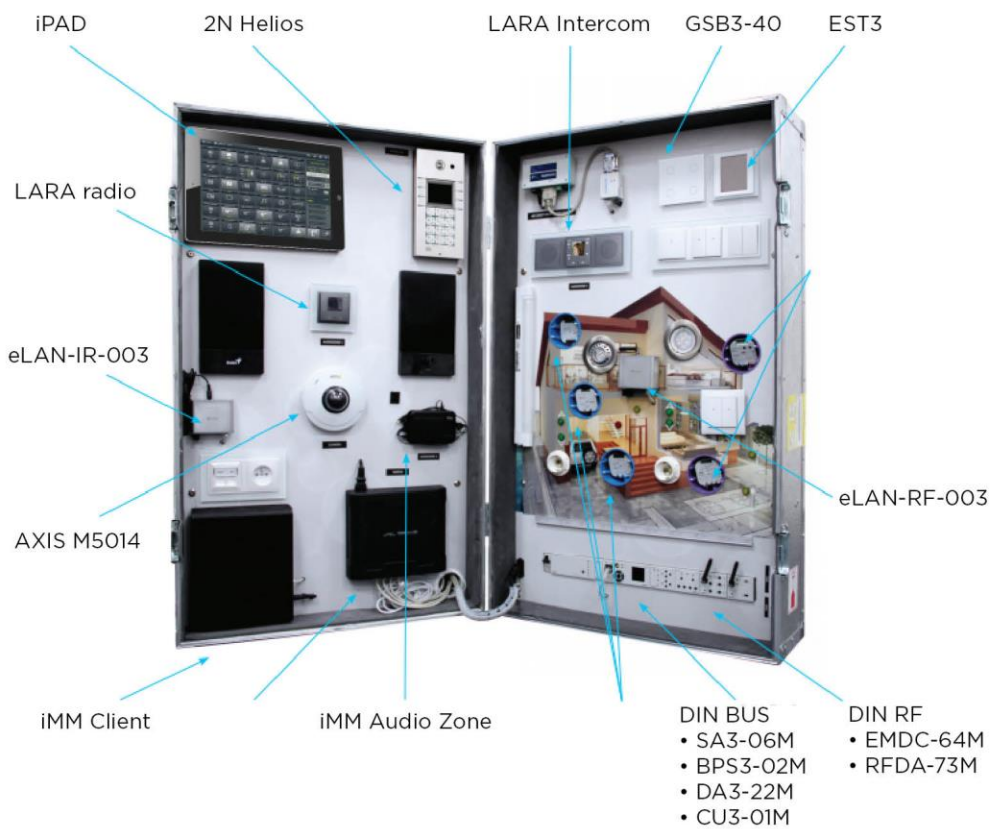

## Smart City



## Energy Management



## LARA



Choose from „Live presentation“ [Click HERE](#)





**PHONE**  
+420 573 514 242



**E-MAIL**  
elko@elkoep.com



**WEB**  
[www.elkoep.com](http://www.elkoep.com)